

An Introduction to

■

Medicinal Chemistry

GRAHAM L. PATRICK

*Department of Chemistry,
Paisley University*

Oxford New York Tokyo
OXFORD UNIVERSITY PRESS
1995

Oxford University Press, Walton Street, Oxford OX2 6DP

Oxford New York
Athens Auckland Bangkok Bombay
Calcutta Cape Town Dar es Salaam Delhi
Florence Hong Kong Istanbul Karachi
Kuala Lumpur Madras Madrid Melbourne
Mexico City Nairobi Paris Singapore
Taipei Tokyo Toronto
and associated companies in
Berlin Ibadan

Oxford is a trade mark of Oxford University Press

Published in the United States
by Oxford University Press Inc., New York

© Graham L. Patrick, 1995

All rights reserved. No part of this publication may be reproduced, stored in a retrieval system, or transmitted, in any form or by any means, without the prior permission in writing of Oxford University Press. Within the UK, exceptions are allowed in respect of any fair dealing for the purpose of research or private study, or criticism or review, as permitted under the Copyright, Designs and Patents Act, 1988, or in the case of reprographic reproduction in accordance with the terms of licences issued by the Copyright Licensing Agency. Enquiries concerning reproduction outside these terms and in other countries should be sent to the Rights Department, Oxford University Press, at the address above.

This book is sold subject to the condition that it shall not, by way of trade or otherwise, be lent, re-sold, hired out, or otherwise circulated without the publisher's prior consent in any form of binding or cover other than that in which it is published and without a similar condition including this condition being imposed on the subsequent purchaser.

A catalogue record for this book is available from the British Library

Library of Congress Cataloging in Publication Data

Patrick, Graham L.

An introduction to medicinal chemistry / Graham L. Patrick. — 1st ed.

Includes bibliographical references and index.

1. Pharmaceutical chemistry. I. Title.

RS403.P38 1995 615/.19—dc20 94-24704

ISBN 0 19 855872 4 (Hbk)

ISBN 0 19 855871 6 (Pbk)

Typeset by Footnote Graphics, Warminster, Wilts
Printed in Great Britain on acid-free paper by
the Bath Press

Preface

This text is aimed at undergraduates who have a basic grounding in chemistry and are interested in a future career in the pharmaceutical industry. It attempts to convey something of the fascination of working in a field which overlaps the disciplines of chemistry, biochemistry, cell biology, and pharmacology.

No previous knowledge of biology is assumed and the first six chapters cover the basics of cell structure, proteins, and nucleic acids as applied to drug design.

Chapters 7, 8, and 9 describe the general tactics employed in developing an effective drug and also the difficulties faced by the medicinal chemist in this task.

Chapters 10, 11, and 12 cover three particular areas of medicinal chemistry and are representative of the classifications which prevail in medicinal chemistry. By doing this, it is hoped that the advantages and disadvantages of the various classification schemes are exemplified.

The three areas of medicinal chemistry described in Chapters 10, 11, and 12 have long histories and much of the early development of these drugs relied heavily on random variations of lead compounds on a trial and error basis. This approach is wasteful and the future of medicinal chemistry lies in the rational design of drugs based on a firm understanding of their biology and chemistry. The development of the antiulcer drug cimetidine represents one of the best examples of the rational approach to medicinal chemistry and is covered in Chapter 13.

Paisley
June 1994

G.L.P.

Acknowledgements

Figure 7.2 and all the figures in Chapter 1 were designed and drawn by Mr G. Leerie, to whom the author is indebted. The author also wishes to express his gratitude to Professor J. Mann for many helpful and constructive comments on the text, and also to Dr D. Marrs for helping with proofreading; however, any errors in the text are the author's responsibility alone.

Contents

Classification of drugs	xiii
1. Drugs and the medicinal chemist	1
2. The why and the wherefore	9
2.1 Why should drugs work?	9
2.2 Where do drugs work?	9
3. Protein structure	15
3.1 The primary structure of proteins	15
3.2 The secondary structure of proteins	16
3.2.1 The alpha helix	16
3.2.2 The beta-pleated sheet	16
3.3 The tertiary structure of proteins	16
3.3.1 Covalent bonds	21
3.3.2 Ionic bonds	21
3.3.3 Hydrogen bonds	21
3.3.4 Van der Waals bonds	22
3.3.5 Repulsive forces	22
3.3.6 Relative importance of binding forces	23
3.4 The quaternary structure of proteins	25
3.5 Conclusion	26
4. Drug action at enzymes	27
4.1 Enzymes as catalysts	27
4.2 How do catalysts lower activation energies?	28
4.3 The active site of an enzyme	30
4.4 Substrate binding at an active site	31
4.4.1 The binding forces	31
4.4.2 Competitive (reversible) inhibitors	32
4.4.3 Non-competitive (irreversible) inhibitors	34
4.4.4 Non-competitive, reversible (allosteric) inhibitors	35
4.5 The catalytic role of enzymes	37
4.5.1 Binding interactions	37
4.5.2 Acid/base catalysis	39
4.5.3 Nucleophilic groups	39
4.6 Medicinal uses of enzyme inhibitors	44

5. Drug action at receptors	45
5.1 The receptor role	45
5.2 Neurotransmitters	47
5.3 Receptors	49
5.4 How does the message get received?	50
5.4.1 Ion channels and their control	50
5.4.2 Membrane-bound enzymes—activation/deactivation	52
5.5 How does a receptor change shape?	54
5.6 The design of agonists	56
5.6.1 Binding groups	57
5.6.2 Position of binding groups	58
5.6.3 Size and shape	60
5.7 The design of antagonists	61
5.7.1 Antagonists acting at the binding site	61
5.7.2 Antagonists acting outwith the binding site	62
5.8 Partial agonists	63
5.9 Desensitization	65
5.10 Tolerance and dependence	65
6. Nucleic acids	68
6.1 Structure of DNA	68
6.1.1 The primary structure of DNA	68
6.1.2 The secondary structure of DNA	70
6.1.3 The tertiary structure of DNA	71
6.2 Drugs acting on DNA	72
6.2.1 Intercalating agents	72
6.2.2 Alkylating agents	74
6.2.3 Drugs acting by chain ‘cutting’	76
6.3 Ribonucleic acid	77
6.4 Drugs acting on RNA	80
6.5 Summary	81
7. Drug development	82
7.1 Screening of natural products	82
7.2 Isolation and purification	83
7.3 Structure determination	83
7.4 Structure–activity relationships	84
7.4.1 The binding role of hydroxyl groups	86
7.4.2 The binding role of amino groups	88
7.4.3 The binding role of aromatic rings	88
7.4.4 The binding role of double bonds	89
7.5 Synthetic analogues	89
7.5.1 Variation of substituents	90
7.5.2 Extension of the structure	92
7.5.3 Chain extensions/contractions	93
7.5.4 Ring expansions/contractions	93
7.5.5 Ring variations	93
7.5.6 Isosteres	94

7.5.7	Simplification of the structure	95
7.5.8	Rigidification of the structure	96
7.6	Receptor theories	97
7.7	The elements of luck and inspiration	101
7.8	Lead compounds	103
7.9	A case study—oxamniquine	104
8.	Pharmacodynamics	111
8.1	Drug distribution and 'survival'	111
8.1.1	Chemical stability	112
8.1.2	Metabolic stability	112
8.1.3	Hydrophilic/hydrophobic balance	113
8.2	Drug dose levels	115
8.3	Drug design for pharmacokinetic problems	116
8.3.1	Variation of substituents	116
8.3.2	Stereoelectronic modifications	116
8.3.3	Metabolic blockers	117
8.3.4	Removal of susceptible metabolic groups	117
8.3.5	Prodrugs	119
8.3.6	Bioisosteres	123
8.3.7	'Sentry' drugs—synergism	124
8.3.8	'Search and destroy' drugs	125
8.3.9	Self-destruct drugs	126
8.3.10	Delivery systems	126
8.4	Testing of drugs	126
8.5	Neurotransmitters as drugs?	127
9.	Quantitative structure–activity relationships (QSAR)	128
9.1	Introduction	128
9.2	Graphs and equations	129
9.3	Physicochemical properties	130
9.3.1	Hydrophobicity	130
9.3.2	Electronic effects	136
9.3.3	Steric factors	140
9.3.4	Other physicochemical parameters	141
9.4	Hansch equation	141
9.5	The Craig plot	143
9.6	The Topliss scheme	145
9.7	Bioisosteres	148
9.8	Planning a QSAR study	149
9.9	Case study	150
10.	Antibacterial agents	154
10.1	The history of antibacterial agents	154
10.2	The bacterial cell	157
10.3	Mechanisms of antibacterial action	158
10.4	Antibacterial agents which act against cell metabolism (antimetabolites)	159
10.4.1	Sulfonamides	159
10.4.2	Examples of other antimetabolites	164

10.5	Antibacterial agents which inhibit cell wall synthesis	166
10.5.1	Penicillins	166
10.5.2	Cephalosporins	181
10.5.3	Novel β -lactam antibiotics	188
10.5.4	The mechanism of action of penicillins and cephalosporins	192
10.6	Antibacterial agents which act on the plasma membrane structure	195
10.7	Antibacterial agents which impair protein synthesis	198
10.7.1	Rifamycins	198
10.7.2	Aminoglycosides	199
10.7.3	Tetracyclines	199
10.7.4	Chloramphenicol	200
10.7.5	Macrolides	201
10.8	Agents which act on nucleic acid transcription and replication	201
10.8.1	Quinolones and fluoroquinolones	201
10.8.2	Aminoacridines	202
10.9	Drug resistance	203
10.9.1	Drug resistance by mutation	203
10.9.2	Drug resistance by genetic transfer	203
10.9.3	Other factors affecting drug resistance	204
11.	The peripheral nervous system—cholinergics, anticholinergics, and anticholinesterases	205
11.1	The peripheral nervous system	206
11.2	Motor nerves of the peripheral nervous system	206
11.2.1	The somatic motor nervous system	207
11.2.2	The autonomic motor nervous system	207
11.3	The neurotransmitters	209
11.4	Actions of the peripheral nervous system	209
11.5	The cholinergic system	210
11.6	Agonists at the cholinergic receptor	212
11.7	Acetylcholine—structure, SAR, and receptor binding	214
11.8	The instability of acetylcholine	218
11.9	Design of acetylcholine analogues	219
11.9.1	Steric hindrance	219
11.9.2	Electronic effects	220
11.9.3	Combining steric and electronic effects	221
11.10	Clinical uses for cholinergic agonists	222
11.11	Antagonists of the muscarinic cholinergic receptor	222
11.11.1	Actions and uses of muscarinic antagonists	222
11.11.2	Muscarinic antagonists	223
11.12	Antagonists of the nicotinic cholinergic receptor	228
11.12.1	Applications of nicotinic antagonists	228
11.12.2	Nicotinic antagonists	229
11.13	Other cholinergic antagonists	233
11.14	The nicotinic receptor—structure	234
11.15	The muscarinic receptor—structure	234
11.16	Anticholinesterases and acetylcholinesterase	235
11.16.1	Effect of anticholinesterases	235

11.16.2	Structure of the acetylcholinesterase enzyme	236
11.16.3	The active site of acetylcholinesterase	236
11.17	Anticholinesterase drugs	238
11.17.1	The carbamates	238
11.17.2	Organophosphorus compounds	242
11.18	Pralidoxime—an organophosphate antidote	244
12.	The opium analgesics	246
12.1	Introduction	246
12.2	Morphine	249
12.2.1	Structure and properties	249
12.2.2	Structure–activity relationships	250
12.3	Development of morphine analogues	255
12.3.1	Variation of substituents	256
12.3.2	Drug extension	256
12.3.3	Simplification or drug dissection	259
12.3.4	Rigidification	265
12.4	Receptor theory of analgesics	269
12.4.1	Beckett–Casy hypothesis	269
12.4.2	Multiple analgesic receptors	271
12.5	Agonists and antagonists	273
12.6	Enkephalins and endorphins	275
12.6.1	Naturally occurring enkephalins and endorphins	275
12.6.2	Analogues of enkephalins	275
12.7	Receptor mechanisms	276
12.7.1	The mu receptor (μ)	277
12.7.2	The kappa receptor (κ)	278
12.7.3	The delta receptor (Δ)	278
12.7.4	The sigma receptor (σ)	279
12.8	The future	279
13.	Cimetidine—a rational approach to drug design	281
13.1	Introduction	281
13.2	In the beginning—ulcer therapy in 1964	282
13.3	Histamine	284
13.4	The theory—two histamine receptors?	284
13.5	Searching for a lead—histamine	285
13.6	Searching for a lead— N^α -guanylhistamine	286
13.7	Developing the lead—a chelation bonding theory	290
13.8	From partial agonist to antagonist—the development of burimamide	292
13.9	Development of metiamide	294
13.10	Development of cimetidine	298
13.11	Cimetidine	300
13.11.1	Biological activity of cimetidine	300
13.11.2	Structure and activity of cimetidine	301
13.11.3	Metabolism of cimetidine	301
13.12	Further studies—cimetidine analogues	302

xii Contents

13.12.1 Conformational isomers	302
13.12.2 Desolvation	303
13.13 Variation of the imidazole ring—ranitidine	308
13.14 Famotidine and nizatidine	309
13.15 H ₂ antagonists with prolonged activity	310
13.16 Comparison of H ₁ and H ₂ antagonists	311
13.17 The H ₂ receptor and H ₂ antagonists	311
Appendix 1 The essential amino acids	313
Appendix 2 The action of nerves	314
Appendix 3 Secondary messengers	320
Appendix 4 Bacteria and bacterial nomenclature	326
Glossary	328
Further reading	330
Index	331

Classification of drugs

The way drugs are classified or grouped can be confusing. Different textbooks group drugs in different ways.

1 *By pharmacological effect*

Drugs are grouped depending on the biological effect they have, e.g. analgesics, antipsychotics, antihypertensives, antiasthmatics, antibiotics, etc.

This is useful if one wishes to know the full scope of drugs available for a certain ailment. However, it should be emphasized that such groupings contain a large and extremely varied assortment of drugs. This is because there is very rarely one single way of dealing with a problem such as pain or heart disease. There are many biological mechanisms which the medicinal chemist can target to get the desired results, and so to expect all painkillers to look alike or to have some common thread running through them is not realistic.

A further point is that many drugs do not fit purely into one category or another and some drugs may have more uses than just one. For example, a sedative might also have uses as an anticonvulsant. To pigeon-hole a drug into one particular field and ignore other possible fields of action is folly.

The antibacterial agents (Chapter 10) are a group of drugs that are classified according to their pharmacological effect.

2 *By chemical structure*

Many drugs which have a common skeleton are grouped together, e.g. penicillins, barbiturates, opiates, steroids, catecholamines, etc.

In some cases (e.g. penicillins) this is a useful classification since the biological activity (e.g. antibiotic activity for penicillins) is the same. However, there is a danger that one could be confused into thinking that all compounds of a certain chemical group have the same biological action. For example, barbiturates may look much alike and yet have completely different uses in medicine. The same holds true for steroids.

It is also important to consider that most drugs can act at several sites of the body and have several pharmacological effects.

The opiates (Chapter 12) are a group of drugs with similar chemical structures.

3 *By target system*

These are compounds which are classed according to whether they affect a certain target system in the body—usually involving a neurotransmitter, e.g. antihistamines, cholinergics, etc.

This classification is a bit more specific than the first, since it is identifying a system with which the drugs interact. It is, however, still a system with several stages and so the same point can be made as before—for example, one would not expect all antihistamines to be similar compounds since the system by which histamine is synthesized, released, interacts with its receptor, and is finally removed, can be attacked at all these stages.

4 *By site of action*

These are compounds which are grouped according to the enzyme or receptor with which they interact. For example, anticholinesterases (Chapter 11) are a group of drugs which act through inhibition of the enzyme acetylcholinesterase.

This is a more specific classification of drugs since we have now identified the precise target at which the drugs act. In this situation, we might expect some common ground between the agents included, since a common mechanism of action is a reasonable though not inviolable assumption.

It is easy, however, to lose the wood for the trees and to lose sight of why it is useful to have drugs which switch off a particular enzyme or receptor site. For example, it is not intuitively obvious why an anticholinergic agent should paralyse muscle and why that should be useful.

1 ■ Drugs and the medicinal chemist

In medicinal chemistry, the chemist attempts to design and synthesize a medicine or a pharmaceutical agent which will benefit humanity. Such a compound could also be called a 'drug', but this is a word which many scientists dislike since society views the term with suspicion.

With media headlines such as 'Drugs Menace', or 'Drug Addiction Sweeps City Streets', this is hardly surprising. However, it suggests that a distinction can be drawn between drugs which are used in medicine and drugs which are abused. Is this really true?

Can we draw a neat line between 'good drugs' like penicillin and 'bad drugs' like heroin? If so, how do we define what is meant by a good or a bad drug in the first place? Where would we place a so-called social drug like cannabis in this divide? What about nicotine, or alcohol?

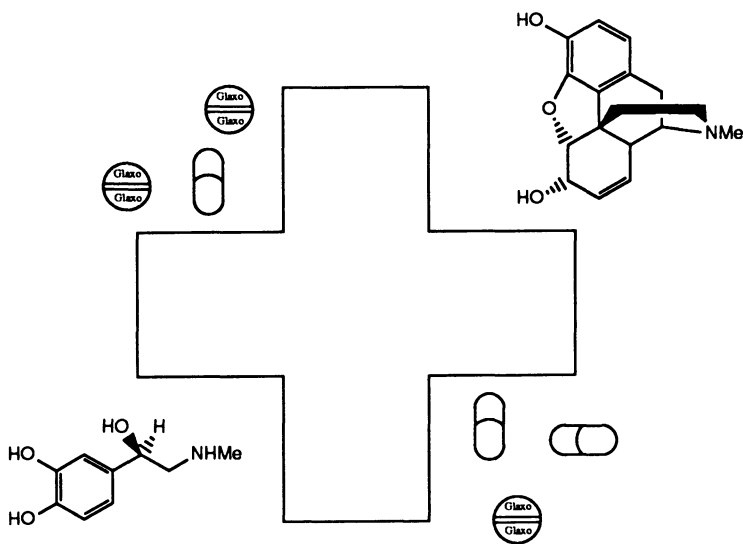

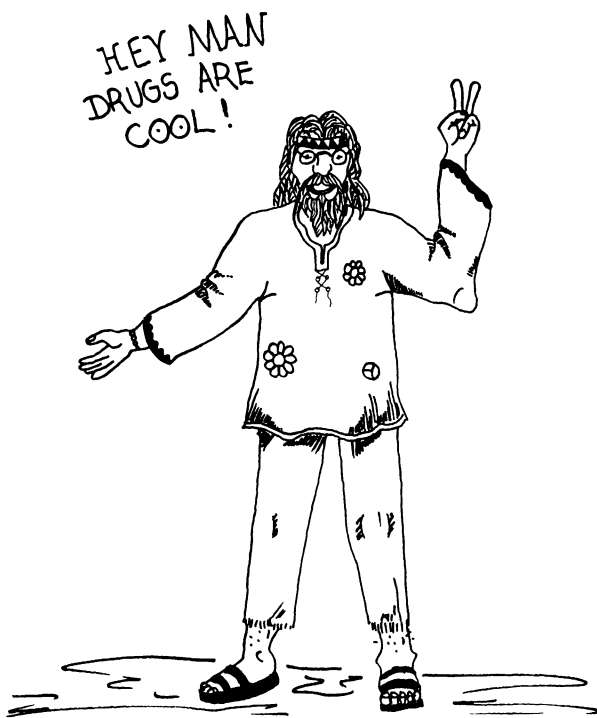

The answers we would get would almost certainly depend on who we were to ask. As far as the law is concerned, the dividing line is defined in black and white. As far as the party-going teenager is concerned, the law is an ass.

As far as we are concerned, the questions are irrelevant. To try and divide drugs into two categories—safe or unsafe, good or bad, is futile and could even be dangerous.

First of all, let us consider the so-called 'good' drugs—the medicines. How 'good' are they? If a medicine is to be truly 'good' it would have to satisfy the following criteria. It would have to do what it is meant to do, have no side-effects, be totally safe, and be easy to take.

How many medicines fit these criteria?

The short answer is 'none'. There is no pharmaceutical compound on the market today which can completely satisfy all these conditions. Admittedly, some come quite close to the ideal. Penicillin, for example, has been one of the most effective anti-bacterial agents ever discovered and has also been one of the safest. Yet it too has drawbacks. It has never been able to kill *all* known bacteria and as the years have gone by, more and more bacterial strains have become resistant.

Nor is penicillin totally safe. There are many examples of patients who show an allergic reaction to penicillin and are required to take alternative antibacterial agents.

Whilst penicillin is a relatively safe drug, there are some medicines which are distinctly dangerous. Morphine is one such example. It is an excellent analgesic, yet it suffers from the serious side-effects of tolerance, respiratory depression, and addiction. It can even kill if taken in excess.

Barbiturates are also known to be dangerous. At Pearl Harbor, American casualties undergoing surgery were given barbiturates as general anaesthetics. However, because of a poor understanding about how barbiturates are stored in the body, many patients received sudden and fatal overdoses. In fact, it is reputed that more casualties died at the hands of the anaesthetists at Pearl Harbor than died of their wounds.

To conclude, the 'good' drugs are not as perfect as one might think.

What about the 'bad' drugs then? Is there anything good that can be said about them? Surely there is nothing we can say in defence of the highly addictive drug heroin?

Well, let us look at the facts about heroin. Heroin is one of the best painkillers known to man. In fact, it was named heroin at the end of the nineteenth century because it was thought to be the 'heroic' drug which would banish pain for good. The drug went on the market in 1898, but five years later the true nature of heroin's addictive properties became evident and the drug was speedily withdrawn from general distribution.

However, heroin is still used in medicine today—under strict control of course.



4 Drugs and the medicinal chemist

The drug is called diamorphine and it is the drug of choice when treating patients dying of cancer. Not only does diamorphine reduce pain to acceptable levels, it also produces a euphoric effect which helps to counter the depression faced by patients close to death. Can we really condemn a drug which can do that as being all 'bad'?

By now it should be evident that the division between good drugs and bad drugs is a woolly one and is not really relevant to our discussion of medicinal chemistry. All drugs have their good points and their bad points. Some have more good points than bad and vice versa, but like people, they all have their own individual characteristics. So how are we to define a drug in general?

One definition could be to classify drugs as 'compounds which interact with a biological system to produce a biological response'.

This definition covers all the drugs we have discussed so far, but it goes further. There are chemicals which we take every day and which have a biological effect on us. What are these everyday drugs?

One is contained in all the cups of tea, coffee, and cocoa which we consume. All of these beverages contain the stimulant caffeine. Whenever you take a cup of coffee, you are a drug user. We could go further. Whenever you crave a cup of coffee, you are a drug addict. Even kids are not immune. They get their caffeine 'shot' from coke or pepsi. Whether you like it or not, caffeine is a drug. When you take it, you experience a change of mood or feeling.

So too, if you are a worshipper of the 'nicotine stick'. The biological effect is

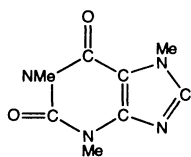

Caffeine

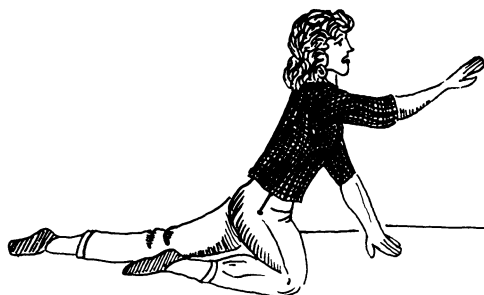



different. In this case you crave sedation or a calming influence, and it is the nicotine in the cigarette smoke which induces that effect.

There can be little doubt that alcohol is a drug and as such causes society more problems than all other drugs put together. One only has to study road accident statistics to appreciate that fact. It has been stated that if alcohol was discovered today, it would be restricted in exactly the same way as cocaine or cannabis. If one considers alcohol in a purely scientific way, it is a most unsatisfactory drug. As many will testify, it is notoriously difficult to judge the correct dose of alcohol required to gain the beneficial effect of 'happiness' without drifting into the higher dose levels which produce unwanted side-effects. Alcohol is also unpredictable in its biological effects. Happiness or depression may result depending on the user's state of mind. On a more serious note, addiction and tolerance in certain individuals have ruined the lives of addicts and relatives alike.

Even food can be a drug. Junk foods and fizzy drinks have been blamed for causing hyperactivity in children. It is believed that junk foods have high concentrations of certain amino acids which can be converted in the body to neurotransmitters. These are chemicals which pass messages between nerves. If an excess of these chemical messengers should accumulate, then too many messages are being transmitted in the brain, leading to the disruptive behaviour observed in susceptible individuals. Allergies due to food additives and preservatives are also well recorded.

Our definition of a drug can also be used to include compounds which we might not at first sight consider to be drugs.



Consider how the following examples fit our definition.

- Morphine—reacts with the body to bring pain relief.
- Snake venom—reacts with the body and may cause death!
- Strychnine—reacts with the body and may cause death!
- LSD—reacts with the body to produce hallucinations.
- Coffee—reacts with the body to waken you up.
- Penicillin—reacts with bacterial cells and kills them.
- Sugar—reacts with the tongue to produce a sense of taste.



All of these compounds fit our definition of drugs. It may seem strange to include poisons and snake venoms as drugs, but they too react with a biological system and produce a biological response—a bit extreme perhaps, but a response all the same.

The idea of poisons and venoms acting as drugs may not appear so strange if we consider penicillin. We have no problem in thinking of penicillin as a drug, but if we were to look closely at how penicillin works, then it is really a poison. It interacts with bacteria (the biological system) and kills them (the biological response). Fortunately for us, penicillin has no effect on human cells.

Even those medicinal drugs which do not act as poisons have the potential to become poisons—usually if they are taken in excess. We have already seen this with morphine. At low doses it is a painkiller. At high doses, it is a poison which kills by suffocation. Therefore, it is important that we treat all medicines as potential poisons and keep them well protected from children searching the house for concealed sweets.

There is a term used in medicinal chemistry known as the therapeutic index which indicates how safe a particular drug is. The therapeutic index is a measure of the drug's beneficial effects at a low dose versus its harmful effects at a high dose. A high therapeutic index means that there is a large safety margin between beneficial and toxic doses. The values for cannabis and alcohol are 1000 and 10 respectively.

If useful drugs can be poisons at high doses, does the opposite hold true? Can a poison be a medicine at low doses? In certain cases, this is found to be the case.

Arsenic is well known as a poison, but arsenic-based compounds were used at the beginning of the century as antiprotozoal agents.

Curare is a deadly poison which was used by the Incas to tip their arrows such that a minor arrow wound would be fatal, yet compounds based on the tubocurarine structure (the active principle of curare) have been used in surgical operations to relax

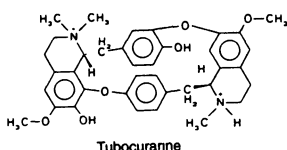
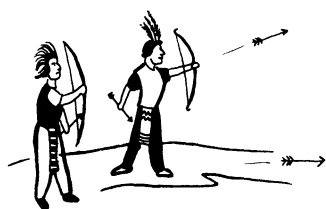

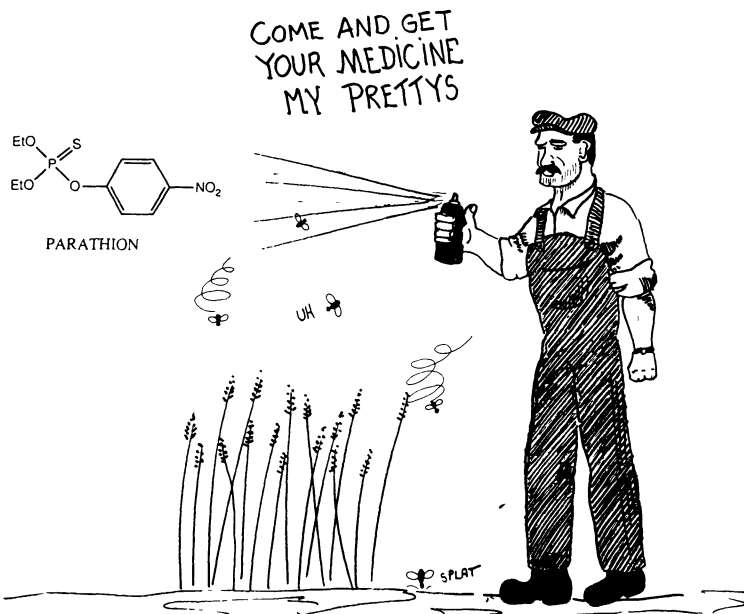

muscles. Under proper control and in the correct dosage, a lethal poison may well have an important medical role.

Since our definition covers any chemical which interacts with any biological system, we could include all pesticides and herbicides as drugs. They interact with bacteria, fungi, and insects, kill them and thus protect plants.

Sugar (or any sweet item for that matter) can be classed as a drug. It reacts with a biological system (the taste buds on the tongue) to produce a biological response (sense of sweetness).

Having discussed what drugs are, we shall now consider why, where, and how drugs act.

2 ■ The why and the wherefore

2.1 *Why should drugs work?*

Why indeed? We take it for granted that they do, but why should chemicals, some of which have remarkably simple structures, have such an important effect on such a complicated and large structure as a human being? The answer lies in the way that the human body operates. If we could see inside our bodies to the molecular level, we would no doubt get a nasty shock, but we would also see a magnificent array of chemical reactions taking place, keeping the body healthy and functioning.

Drugs may be mere chemicals but they are entering a world of chemical reactions with which they can interact. Therefore, there should be nothing odd in the fact that they can have an effect. The surprise might be that they can have such specific effects. This is more a result of *where* they react in the body.

2.2 *Where do drugs work?*

Since life is made up of cells, then quite clearly drugs must act on cells. The structure of a typical cell is shown in Fig. 2.1.

All cells in the human body contain a boundary wall called the cell membrane. This encloses the contents of the cell—the cytoplasm.

The cell membrane seen under the electron microscope consists of two identifiable layers. Each layer is made up of an ordered row of phosphoglyceride molecules such as phosphatidylcholine (lecithin).¹ Each phosphoglyceride molecule consists of a small polar head-group, and two long hydrophobic chains (Fig. 2.2).

In the cell membrane, the two layers of phospholipids are arranged such that the hydrophobic tails point to each other and form a fatty, hydrophobic centre, while the

¹ The outer layer of the membrane is made up of phosphatidylcholine whereas the inner layer is made up of phosphatidylethanolamine, phosphatidylserine, and phosphatidylinositol.

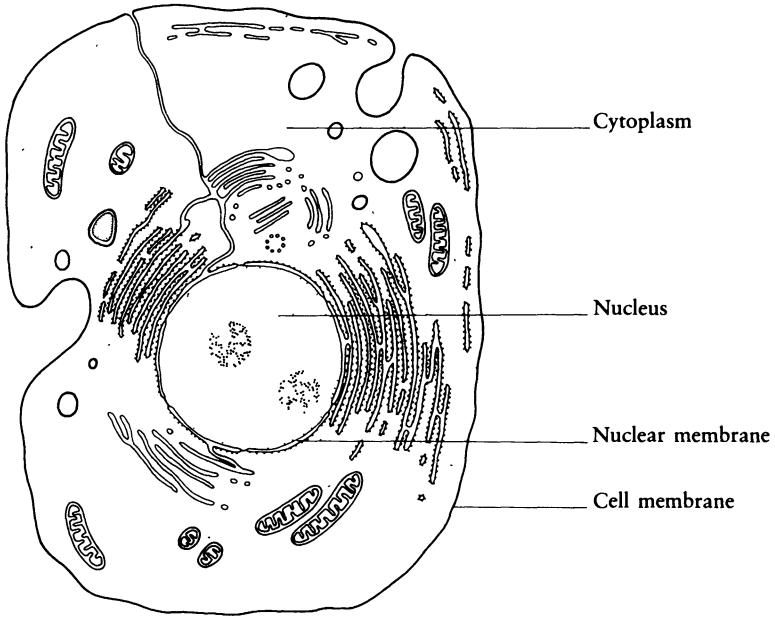

Fig. 2.1 A typical cell. Taken from J. Mann, *Murder, magic, and medicine*, Oxford University Press (1992), with permission.

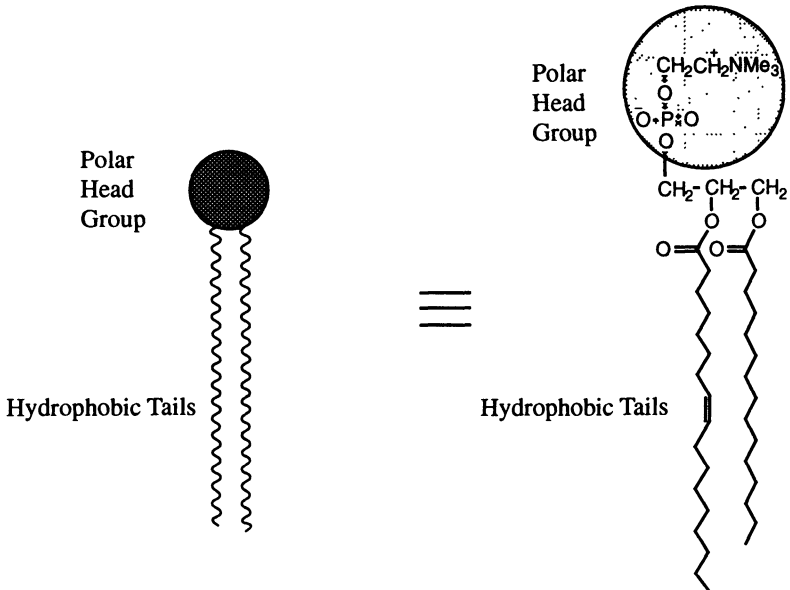

Fig. 2.2 Phosphoglyceride structure.

ionic head-groups are placed at the inner and outer surfaces of the cell membrane (Fig. 2.3). This is a stable structure since the ionic, hydrophilic head-groups can interact with the aqueous media inside and outside the cell, while the hydrophobic tails maximize van der Waals bonding with each other and are kept away from the aqueous environments. The overall result of this structure is to construct a fatty barrier between the cell's interior and its surroundings.

The membrane is not just made up of phospholipids, however. There are a large variety of proteins situated in the cell membrane (Fig. 2.4). Some proteins lie on the surface of the membrane. Others are embedded in it with part of their structure exposed to one surface of the membrane or the other. Other proteins traverse the whole membrane and have areas exposed both to the outside and the inside of the cell. The extent to which these proteins are embedded within the cell membrane structure depends on the type of amino acid present. Portions of protein which are embedded in the cell membrane will have a large number of hydrophobic amino acids, whereas those portions which stick out on the surface will have a large number of hydrophilic

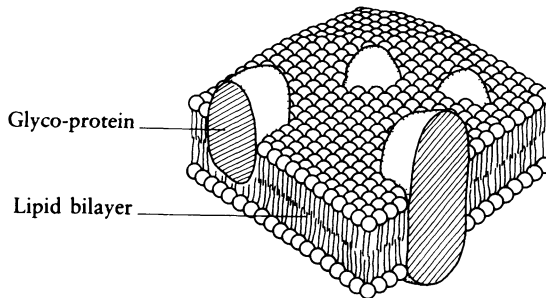

Fig. 2.3 Cell membrane. Taken from J. Mann, *Murder, magic, and medicine*, Oxford University Press (1992), with permission.

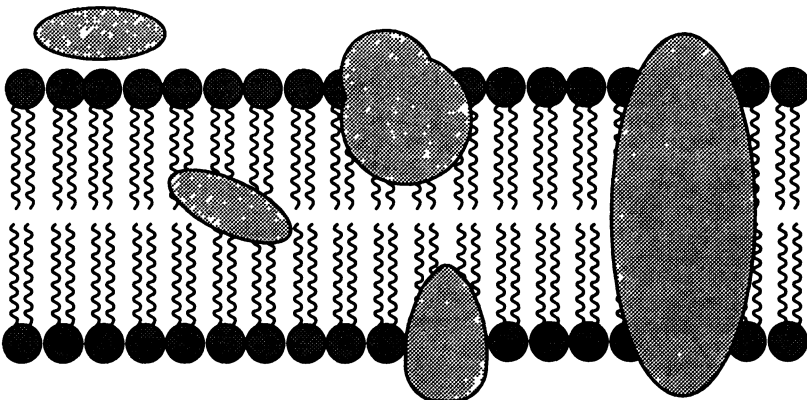

Fig. 2.4 The position of proteins associated with the cell membrane.

amino acids. Many surface proteins also have short chains of carbohydrates attached to them and are thus classed as glycoproteins. These carbohydrate segments are thought to be important towards cell recognition.

Within the cytoplasm there are several structures, one of which is the nucleus. This acts as the 'control centre' for the cell. The nucleus contains the genetic code—the DNA—and contains the blueprints for the construction of all the cell's enzymes.

There are many other structures within a cell, such as the mitochondria, the golgi apparatus, and the endoplasmic reticulum, but it is not the purpose of this book to look at the structure and function of these organelles. Suffice it to say that different drugs act at different locations in the cell and there is no one target site which we could pinpoint as the spot where drugs act. Nor would we get any closer to understanding how drugs work by cataloguing which drug acts at which particular cell component.

We need to magnify the picture, move down to the molecular level, and find out what types of molecules in the cell are affected by drugs. When we do that, we find that there are three main molecular targets:

- (1) lipids
- (2) proteins (glycoproteins)
- (3) nucleic acids

The number of drugs which interact with lipids are relatively small and, in general, they all act in the same way—by disrupting the lipid structure of cell membranes.

Anaesthetics work by interacting with the lipids of cell membranes to alter the structure and conducting properties of the cell membrane.

The antifungal agent—amphotericin B (Fig. 2.5)—(used against athletes foot) interacts with the lipids of fungal cell membranes to build 'tunnels' through the membrane. Once in place, the contents of the cell are drained away and the cell is killed.

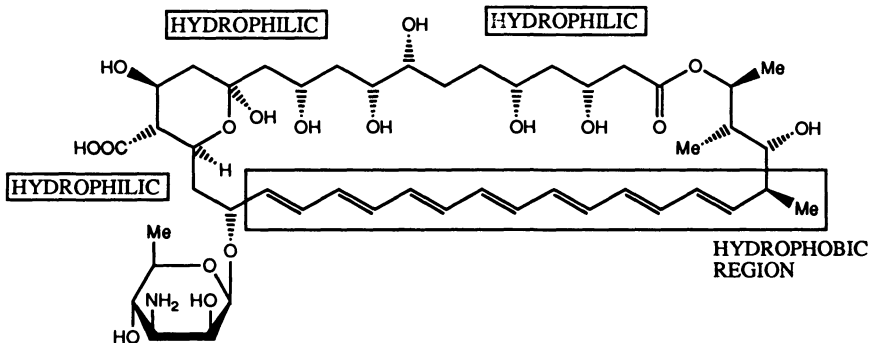

Fig. 2.5 Amphotericin B.

Amphotericin is a fascinating molecule in that one half of the structure is made up of double bonds and is hydrophobic, while the other half contains a series of hydroxyl groups and is hydrophilic. It is a molecule of extremes and as such is ideally suited to act on the cell membrane in the way that it does. Several amphotericin molecules cluster together such that the alkene chains are to the exterior and interact favourably with the hydrophobic centre of the cell membrane. The tunnel resulting from this cluster is lined with the hydroxyl groups and so is hydrophilic, allowing the polar contents of the cell to escape (Fig. 2.6).

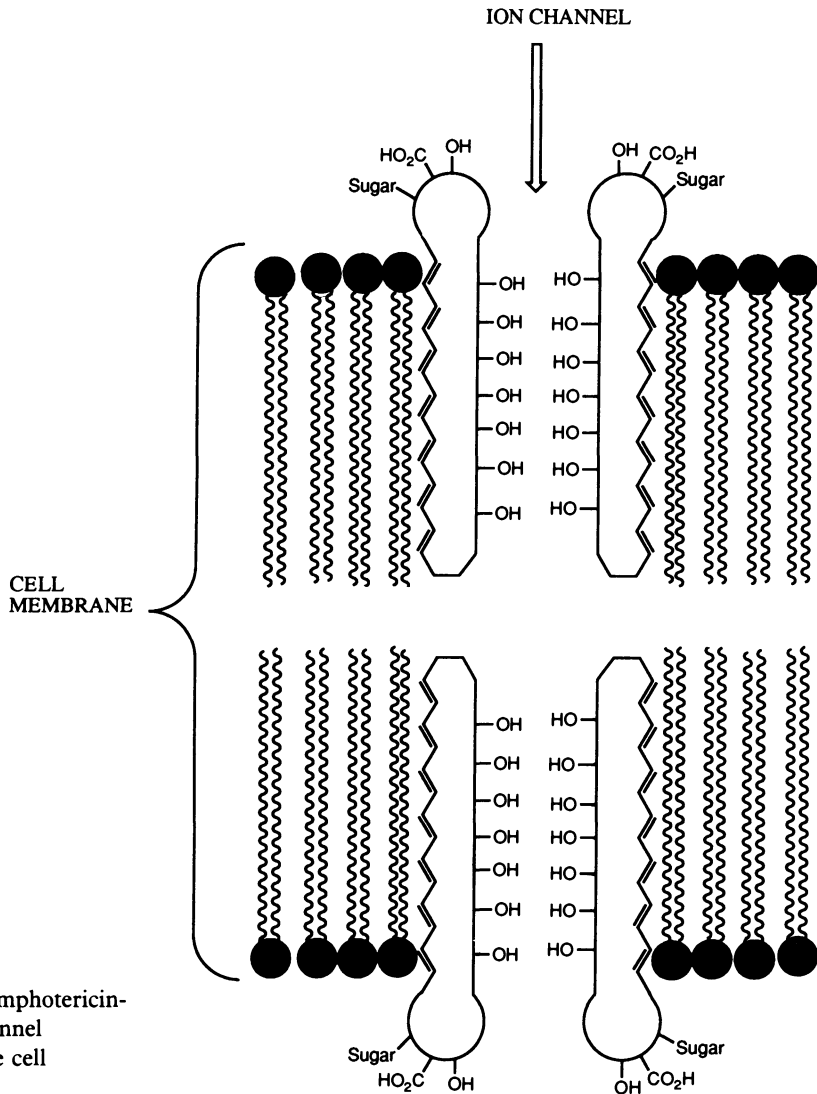

Fig. 2.6 Amphotericin-formed channel through the cell membrane.

14 The why and the wherefore

The antibiotics valinomycin and gramicidin A operate by acting within the cell membrane as ion carriers and ion channels respectively (see Chapter 10).

These drugs apart, the vast majority of drugs interact with proteins or nucleic acids, and in particular with proteins. We shall therefore concentrate our attention in the next three chapters on proteins, then consider nucleic acids in Chapter 6.

3 ■ Protein structure

In order to understand how drugs interact with proteins, it is necessary to understand their structure.

Proteins have four levels of structure—primary, secondary, tertiary, and quaternary.

3.1 The primary structure of proteins

The primary structure is quite simply the order in which the individual amino acids making up the protein are linked together through peptide bonds (Fig. 3.1).

The 20 common amino acids found in man are listed below and the structures are shown in Appendix 1.

Synthesized in the human body	Essential to the diet
Alanine (Ala)	Histidine (His)
Arginine (Arg)	Isoleucine (Ile)
Asparagine (Asn)	Leucine (Leu)
Aspartic acid (Asp)	Lysine (Lys)
Cysteine (Cys)	Methionine (Met)
Glutamic acid (Glu)	Phenylalanine (Phe)
Glutamine (Gln)	Threonine (Thr)
Glycine (Gly)	Tryptophan (Trp)
Proline (Pro)	Valine (Val)
Serine (Ser)	
Tyrosine (Tyr)	

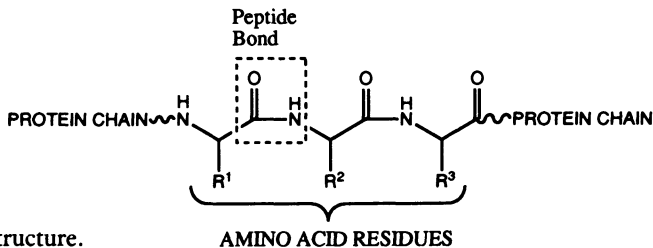

Fig. 3.1 Primary structure.

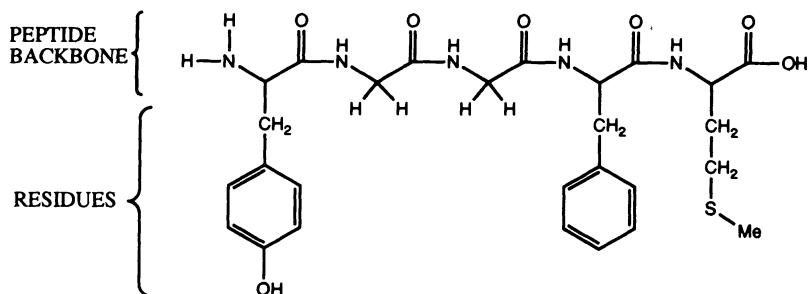

Fig. 3.2 Met-enkephalin.

SHORTHAND NOTATION: H-TYR-GLY-GLY-PHE-MET-OH

The primary structure of Met-enkephalin (one of the body's own painkillers) is shown in Fig. 3.2.

3.2 The secondary structure of proteins

The secondary structure of proteins consists of regions of ordered structures taken up by the protein chain. There are two main structures—the alpha helix and the beta-pleated sheet.

3.2.1 The alpha helix

The alpha helix results from coiling of the protein chain such that the peptide bonds making up the backbone are able to form hydrogen bonds between each other. These hydrogen bonds are directed along the axis of the helix as shown in Fig. 3.3. The residues of the component amino acids 'stick out' at right angles from the helix, thus minimizing steric interactions and further stabilizing the structure.

3.2.2 The beta-pleated sheet

The beta-pleated sheet is a layering of protein chains, one on top of another as shown in Fig. 3.4. Here too, the structure is held together by hydrogen bonds between the peptide links. The residues are situated at right angles to the sheets, once again to reduce steric interactions.

In structural proteins such as wool and silk, secondary structures are extensive and determine the overall shape and properties of such proteins.

3.3 The tertiary structure of proteins

The tertiary structure is the overall 3D shape of a protein. Structural proteins are quite ordered in shape, whereas other proteins such as enzymes and receptors fold up on themselves to form more complex structures. The tertiary structure of enzymes

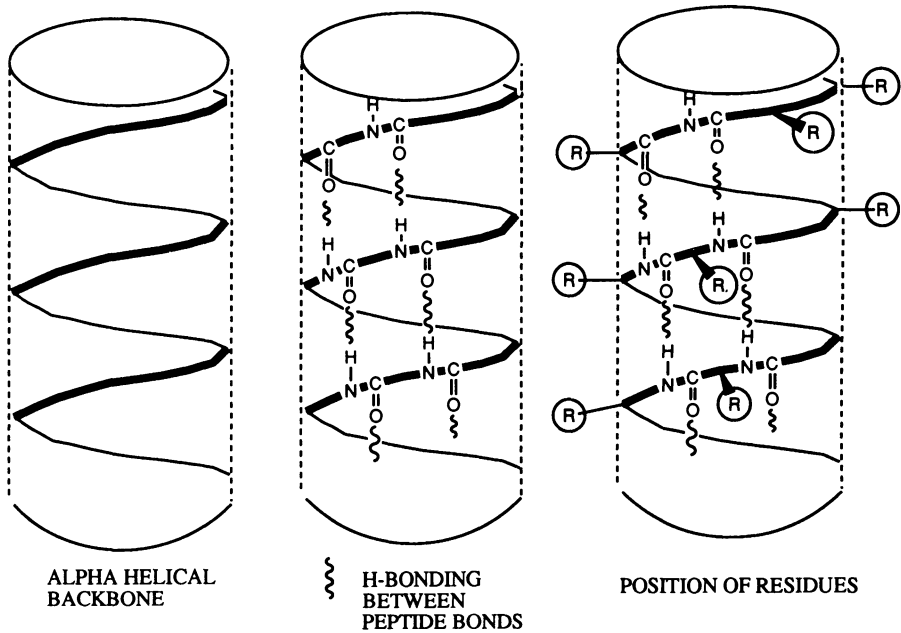

Fig. 3.3 The alpha helix.

and receptors is crucial to their function and also to their interaction with drugs. Therefore, it is important to appreciate the forces which control their tertiary structure.

Enzymes and receptors have a great variety of amino acids arranged in what appears to be a random fashion—the primary structure of the protein. Regions of secondary structure may also be present, but the extent varies from protein to protein. For example, myoglobin (a protein which stores oxygen molecules) has extensive regions of alpha-helical secondary structure (Fig. 3.5), whereas the digestive enzyme chymotrypsin has very little secondary structure. Nevertheless, the protein chains in both myoglobin and chymotrypsin fold up upon themselves to form a complex globular shape such as that shown for myoglobin (Fig. 3.5).

How does this come about?

At first sight the 3D structure of myoglobin looks like a ball of string after the cat has been at it. In fact, the structure shown is a very precise shape which is taken up by every molecule of myoglobin synthesized in the body. There is no outside control or directing force making the protein take up this shape. It occurs spontaneously and is a consequence of the protein's primary structure¹—that is, the amino acids making up the protein and the order in which they are linked. This automatic folding of proteins takes place even as the protein is being synthesized in the cell (Fig. 3.6).

¹ Some proteins contain species known as cofactors (e.g. metal ions or small organic molecules) which also have an effect on tertiary structure.

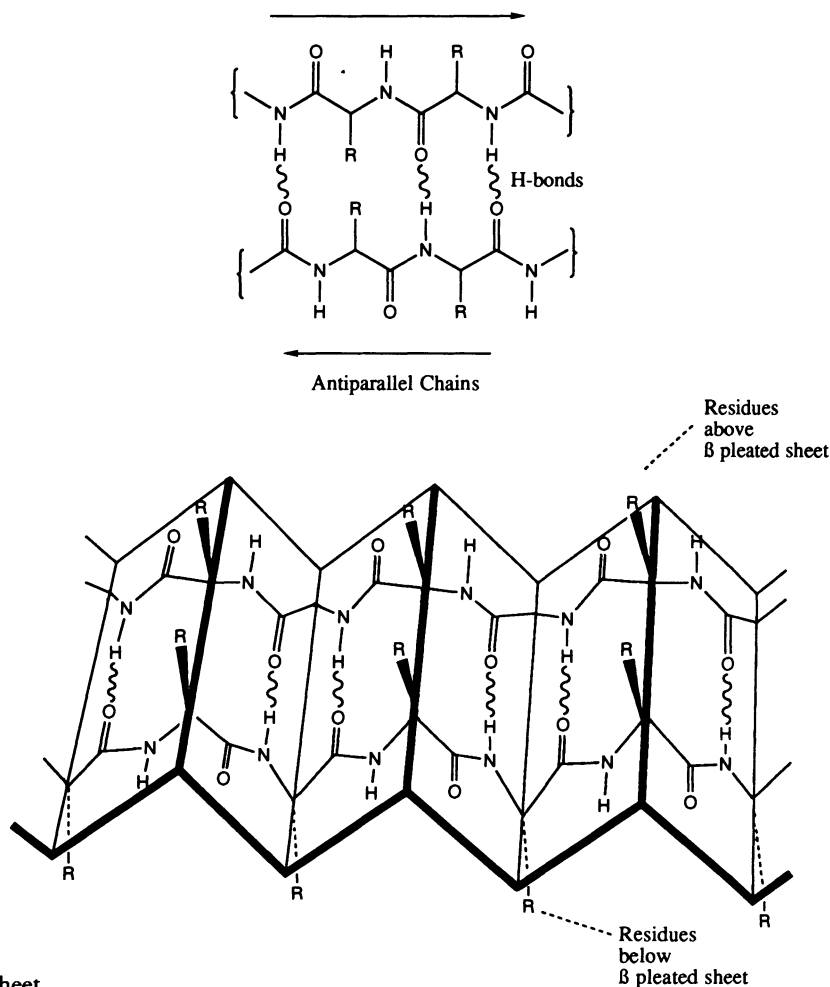

Fig. 3.4 β -pleated sheet.

Proteins are synthesized within cells on nucleic acid bodies called ribosomes. The ribosomes move along 'ticker-tape' shaped molecules of another nucleic acid called messenger RNA. This messenger RNA contains the code for the protein and is called a messenger since it has carried the message from the cell's DNA. The mechanism by which this takes place need not concern us here. We need only note that the ribosome holds on to the growing protein chain as the amino acids are added on one by one. As the chain grows, it automatically folds into its 3D shape such that by the time the protein is fully synthesized and released from the ribosome, the 3D shape is already adopted. The 3D shape is identical for every molecule of the particular protein being synthesized.

This poses a problem. Why should a chain of amino acids take up such a precise 3D shape? At first sight, it does not make sense. If we place a length of string on the table,

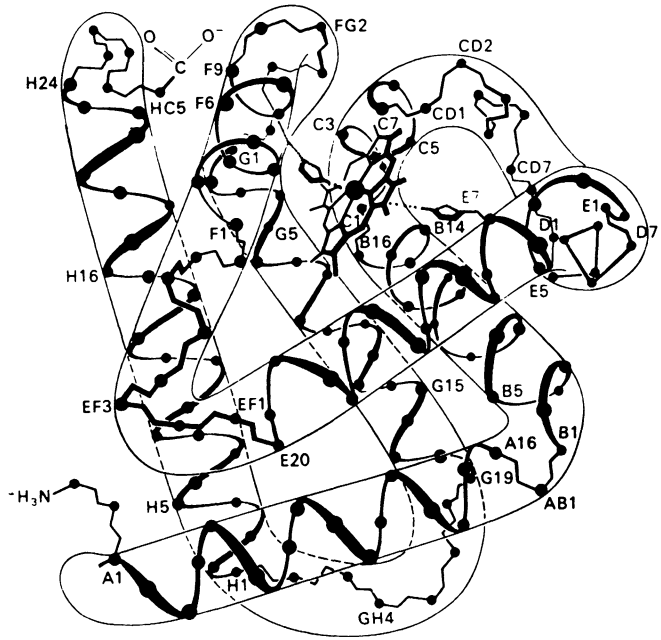

Fig. 3.5 Myoglobin. Taken from Stryer, *Biochemistry*, 3rd edn, Freeman (1988), with permission.

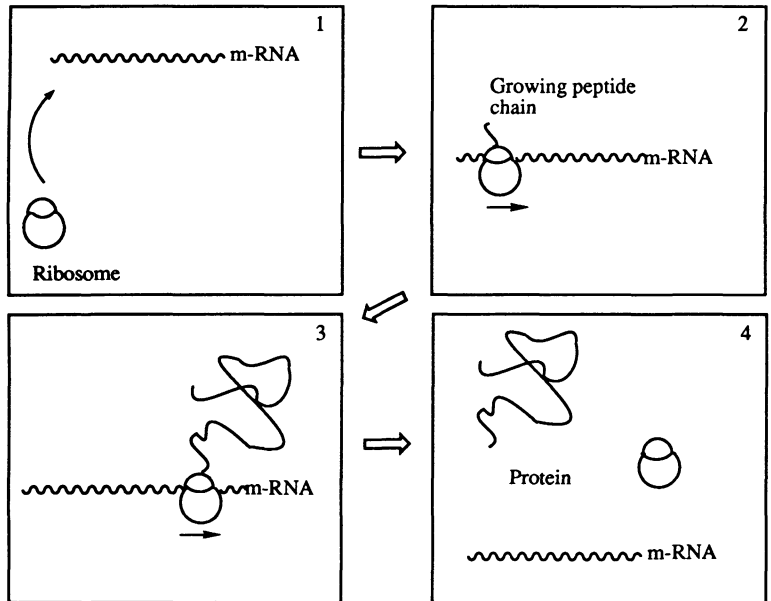

Fig. 3.6 Protein synthesis.

it does not fold itself up into a precise complex shape. So why should a ‘string’ of amino acids do such a thing?

The answer lies in the fact that a protein is not just a bland length of string. It has a whole range of chemical functional groups attached along the length of its chain.

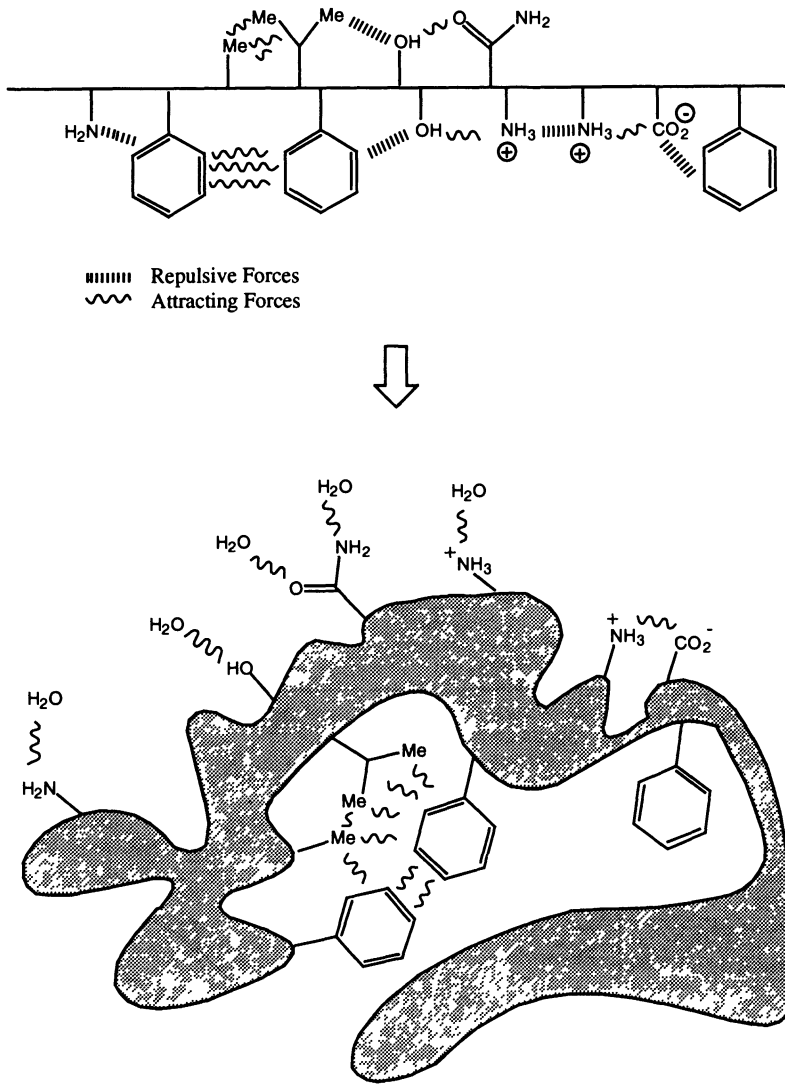

Fig. 3.7 Forces producing tertiary structure.

These are, of course, the residues of each amino acid making up the chain. These residues can interact with each other. Some will attract each other. Others will repel. Thus the protein will twist and turn to minimize the unfavourable interactions and to maximize the favourable ones until the most favourable shape (conformation) is found—the tertiary structure (Fig. 3.7).

What then are these important forces? Let us consider the attracting or binding forces first of all. There are four to consider: covalent bonds; ionic bonds; hydrogen bonds; and van der Waals bonds.

3.3.1 Covalent bonds

Covalent bonds are the strongest bonding force available

$$\text{Bond strength (S-S)} = 250 \text{ kJ mol}^{-1}$$

When two cysteine residues are close together, a covalent disulfide bond can be formed between them as a result of oxidation. A covalent bonded bridge is thus formed between two different parts of the protein chain (Fig. 3.8).

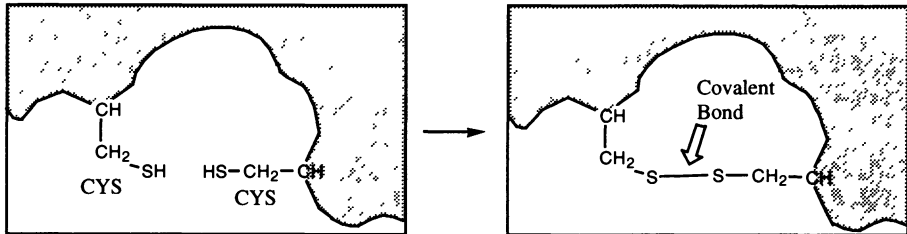

Fig. 3.8 Covalent bond.

3.3.2 Ionic bonds

Ionic bonds are a strong bonding force between groups having opposite charges

$$\text{Bond strength} = 20 \text{ kJ mol}^{-1}$$

An ionic bond can be formed between the carboxylate ion of an acidic residue such as aspartic acid and the ammonium ion of a basic residue such as lysine (Fig. 3.9).

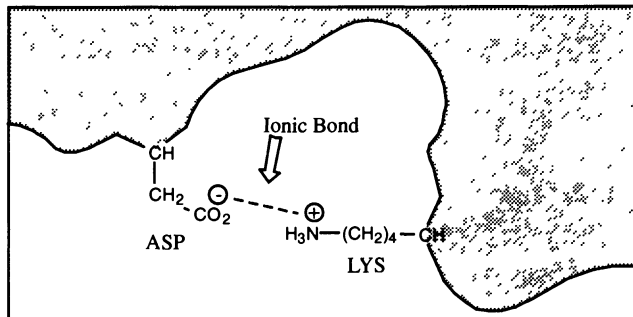

Fig. 3.9 Ionic bond.

3.3.3 Hydrogen bonds

$$\text{Bond strength} = 7\text{--}40 \text{ kJ mol}^{-1}$$

Hydrogen bonds are formed between electronegative atoms, such as oxygen, and protons attached to electronegative atoms (Fig. 3.10).

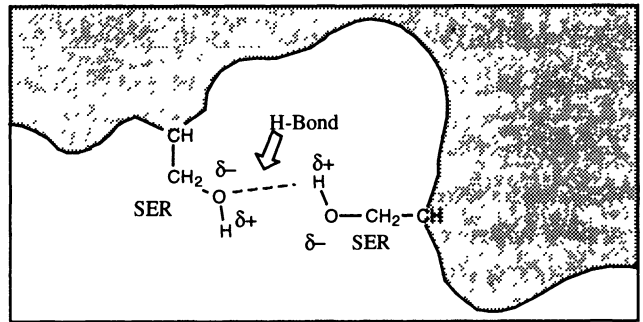

Fig. 3.10 Hydrogen bond.

3.3.4 Van der Waals bonds

$$\text{Bond strength} = 1.9 \text{ kJ mol}^{-1}$$

The van der Waals bonding force results from an interaction between hydrophobic molecules (for example, between two aromatic residues such as phenylalanine (Fig. 3.11) or between two aliphatic residues such as valine). It arises from the fact that the electronic distribution in these neutral, non-polar residues is never totally even or symmetrical. As a result, there are always transient areas of high electron density and low electron density, such that an area of high electron density on one residue can have an attraction for an area of low electron density on another molecule.

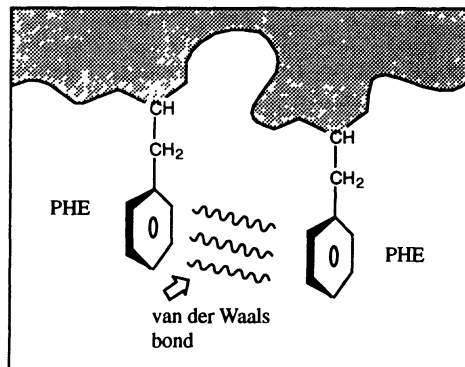

Fig. 3.11 Van der Waals bond.

3.3.5 Repulsive forces

Repulsive forces would arise if a hydrophilic group such as an amino function was too close to a hydrophobic group such as an aromatic ring. Alternatively, two charged groups of identical charge would be repelled.

3.3.6 Relative importance of binding forces

Based on the strengths of the four types of bonds above, we might expect the relative importance of the bonding forces to follow the same order as their strengths, that is,

covalent, ionic, hydrogen bonding, and finally van der Waals. In fact, the opposite is usually true. In most proteins, the most important binding forces in tertiary structure are those due to van der Waals interactions and hydrogen bonding, while the least important forces are those due to covalent and ionic bonding.

There are two reasons for this.

First of all, in most proteins there are far more van der Waals and hydrogen bonding interactions possible, compared to covalent or ionic bonding. We only need to consider the number and types of amino acids in any typical globular protein to see why. The only covalent bond which can contribute to tertiary structure is a disulfide bond. Only one amino acid out of our list can form such a bond—cysteine. However, there are eight amino acids which can interact with each other through van der Waals bonding: Gly, Ala, Val, Leu, Ile, Phe, Pro and Met.

There *are* examples of proteins with a large number of disulfide bridges, where the relative importance of the covalent link to tertiary structure *is* more significant. Disulfide links are also more significant in small polypeptides such as the peptide hormones vasopressin (Fig. 3.12) and oxytocin (Fig. 3.13). However, in the majority of proteins, disulfide links play a minor role in controlling tertiary structure.

As far as ionic bonding is concerned, only four amino acids (Asp, Glu, Lys, Arg) are involved, whereas eight amino acids can interact through hydrogen bonding (Ser, Thr, Cys, Asn, Gln, His, Tyr, Trp). Clearly, the number of possible ionic and covalent bonds is greatly outnumbered by the number of hydrogen bonds or van der Waals interactions.

There is a second reason why van der Waals interactions, in particular, can be the most important form of bonding in tertiary structure. Proteins do not exist in a vacuum. The body is mostly water and as a result all proteins will be surrounded by this medium. Therefore, amino acid residues at the surface of proteins must interact with water molecules. Water is a highly polar compound which forms strong hydrogen bonds. Thus, water would be expected to form strong hydrogen bonds to the hydrogen bonding amino acids previously mentioned.

Water can also accept a proton to become positively charged and can form ionic bonds to aspartic and glutamic acids (Fig. 3.14).

Therefore, water is capable of forming hydrogen bonds or ionic bonds to the following amino acids: Ser, Thr, Cys, Asn, Gln, His, Tyr, Trp, Asp, Glu, Lys, Arg. These polar amino acids are termed hydrophilic. The remaining amino acids (Gly, Ala, Val, Leu, Ile, Phe, Pro, Met) are all non-polar amino acids which are hydrophobic or lipophilic. As a result, they are repelled by water.

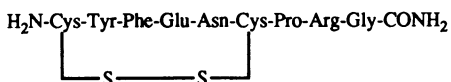

Fig. 3.12 Vasopressin.

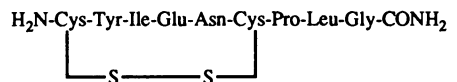

Fig. 3.13 Oxytocin.

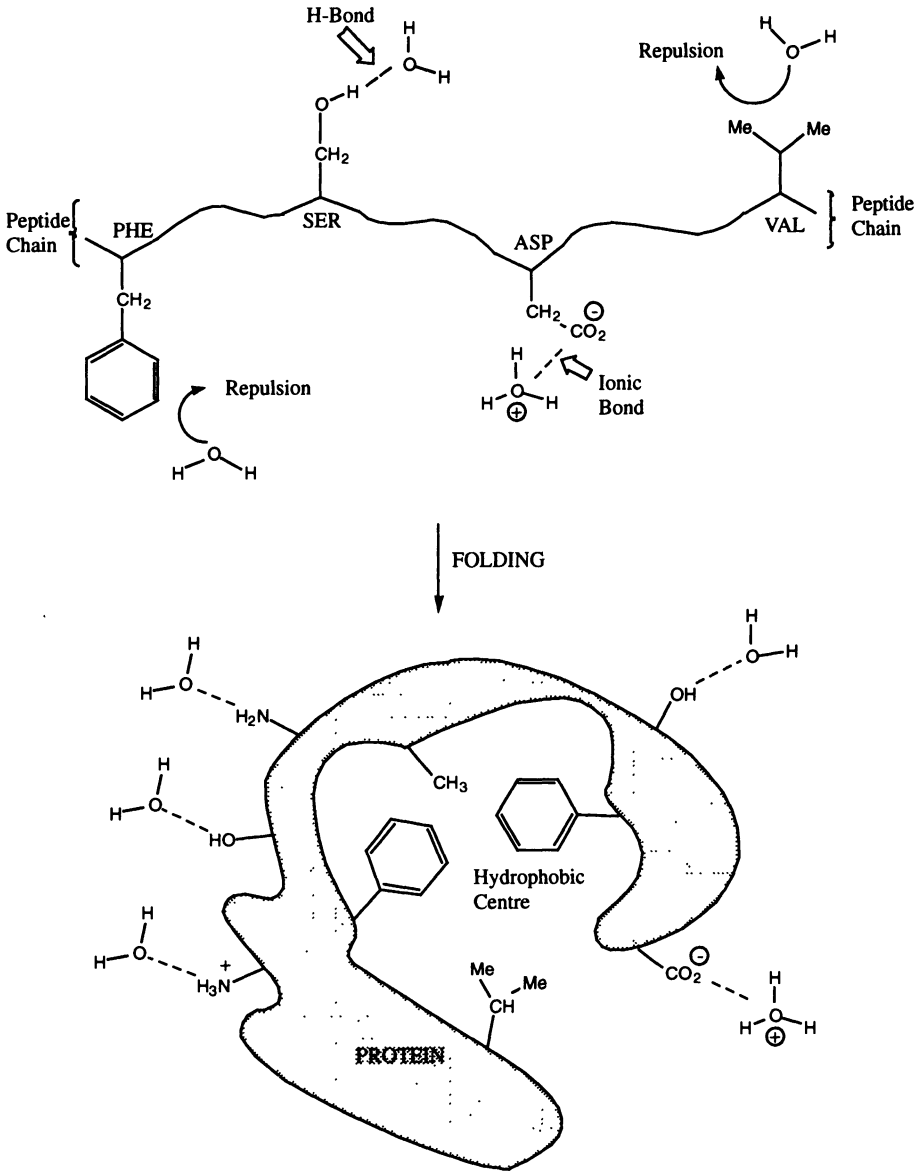

Fig. 3.14 Bonding interactions with water.

Therefore, the most stable tertiary structure of a protein will be the one where most of the hydrophilic groups are on the surface so that they can interact with water, and most of the hydrophobic groups are in the centre so that they can avoid the water and interact with each other.

Since hydrophilic amino acids can form ionic/hydrogen bonds with water, the

number of ionic and hydrogen bonds contributing to the tertiary structure is reduced. The hydrophobic amino acids in the centre have no choice in the matter and must interact with each other. Thus, the hydrophobic interactions within the structure outweigh the hydrophilic interactions and control the shape taken up by the protein.

One important feature of this tertiary structure is that the centre of the proteins is hydrophobic and non-polar. This has important consequences as far as the action of enzymes is concerned and helps to explain why reactions which should be impossible in an aqueous environment can take place in the presence of enzymes. The enzyme can provide a non-aqueous environment for the reaction to take place.

3.4 *The quaternary structure of proteins*

Quaternary structure is confined to those proteins which are made up of a number of protein subunits (Fig. 3.15). For example, haemoglobin is made up of four protein molecules—two identical alpha subunits and two identical beta subunits (not to be confused with the alpha and beta terminology used in secondary structure). The quaternary structure of haemoglobin is the way in which these four protein units associate with each other.

Since this must inevitably involve interactions between the exterior surfaces of proteins, ionic bonding can be more important to quaternary structure than it is to tertiary structure. Nevertheless, hydrophobic (van der Waals) interactions have a role to play. It is not possible for a protein to fold up such that all hydrophobic groups are placed to the centre. Some such groups may be stranded on the surface. If they form a small hydrophobic area on the protein surface, there would be a distinct advantage for two protein molecules to form a dimer such that the two hydrophobic areas face each other rather than be exposed to an aqueous environment.

3.5 Conclusion

We have now discussed the four types of structure. The tertiary structure is the most important feature as far as drug action is concerned, although it must be emphasized

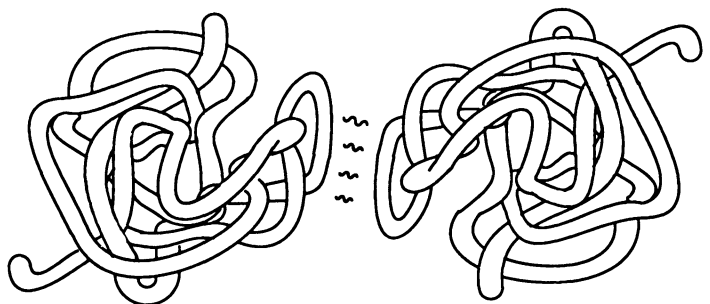

Fig. 3.15 Quaternary structure.

again that tertiary structure is a consequence of primary structure. Tertiary structure is a result of interactions between different amino acid residues and interactions between amino acids and water.

We are now ready to discuss the two types of protein with which drugs interact—enzymes and receptors.

4 ■ Drug action at enzymes

4.1 Enzymes as catalysts

Enzymes are the body's catalysts. Without them, the cell's chemical reactions would be too slow to be useful, and many would not occur at all. A catalyst is an agent which speeds up a chemical reaction without being changed itself.

An example of a catalyst used frequently in the laboratory is palladium on activated charcoal (Fig. 4.1)

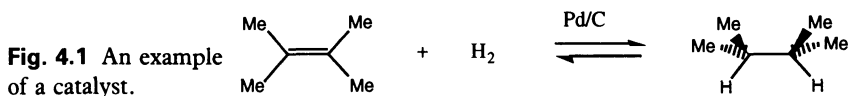

Note that the above reaction is shown as an equilibrium. It is therefore more correct to describe a catalyst as an agent which can speed up the approach to equilibrium. In an equilibrium reaction, a catalyst will speed up the reverse reaction just as efficiently as the forward reaction. Consequently, the final equilibrium concentrations of the starting materials and products are unaffected by a catalyst.

How do catalysts affect the rate of a reaction without affecting the equilibrium? The answer lies in the existence of a high-energy intermediate or transition state which must be formed before the starting material can be converted to the product. The difference in energy between the transition state and the starting material is the activation energy, and it is the size of this activation energy which determines the rate of a reaction rather than the difference in energy between the starting material and the product (Fig. 4.2).

A catalyst acts to reduce the activation energy by helping to stabilize the transition state. The energy of the starting material and products are unaffected, and therefore the equilibrium ratio of starting material to product is unaffected.

We can relate energy, and the rate and equilibrium constants with the following equations:

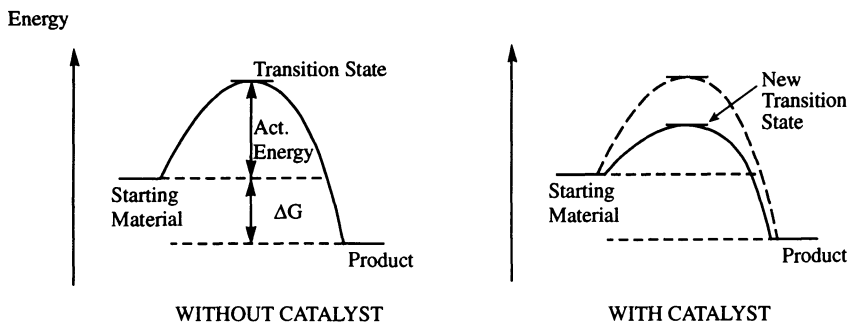

Fig. 4.2 Activation energy.

Energy difference = $\Delta G = -RT \ln K$ where $K = \text{equilibrium constant}$
 $= \frac{[\text{products}]}{[\text{reactants}]}$
 $R = 8.314 \text{ J mol}^{-1} \text{ K}^{-1}$
 $T = \text{temperature}$

Rate constant = $k = Ae^{-E/RT}$ where $E = \text{activation energy}$
 $A = \text{frequency factor}$

Note that the rate constant k has no dependence on the equilibrium constant K .

We have stated that catalysts (and enzymes) speed up reaction rates by lowering the activation energy, but we have still to explain how.

4.2 How do catalysts lower activation energies?

There are several factors at work.

- Catalysts provide a reaction surface or environment.
- Catalysts bring reactants together.
- Catalysts position reactants correctly so that they easily attain their transition state configurations.
- Catalysts weaken bonds.
- Catalysts may participate in the mechanism.

We can see these factors at work in our example of hydrogenation with a palladium–charcoal catalyst (Fig. 4.3).

In this reaction, the catalyst surface interacts with the hydrogen molecule and in doing so weakens the H–H bond. The bond is then broken and the hydrogen atoms are bound to the catalyst. The catalyst can then interact with the alkene molecule, so weakening the pi bond of the double bond. The hydrogen atoms and the alkene molecule are positioned on the catalyst conveniently close to each other to allow easy transfer of the hydrogens from catalyst to alkene. The alkane product then departs, leaving the catalyst as it was before the reaction.

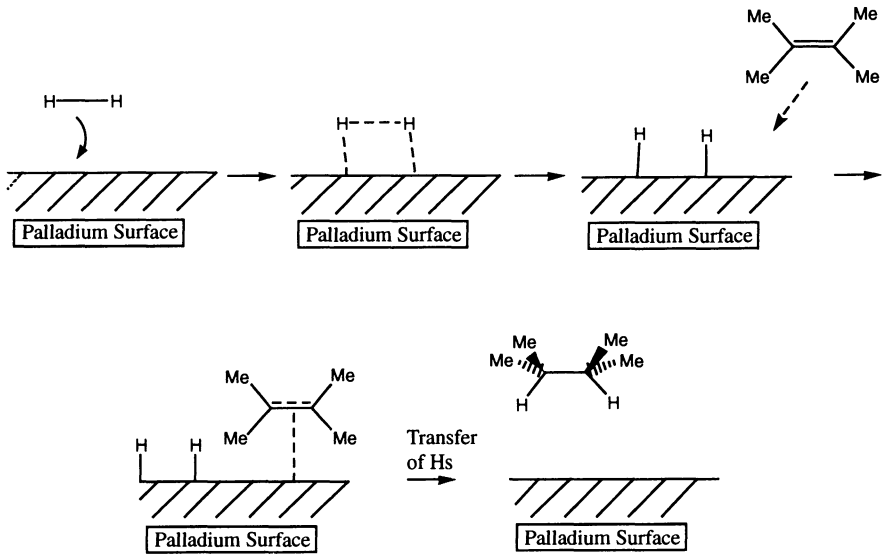

Fig. 4.3 Action of a palladium–charcoal catalyst.

Therefore, the catalyst helps the reaction by providing a surface to bring the two substrates together. It participates in the reaction by binding the substrates and breaking high-energy bonds, and then it holds the reagents close together to increase the chance of them reacting with each other.

Enzymes may have more complicated structures than, say, a palladium surface, but they catalyse reactions in the same way. They act as a surface or focus for the reaction, bringing the substrate or substrates together and holding them in the best position for reaction. The reaction takes place, aided by the enzyme, to give products which are then released (Fig. 4.4). Note again that it is a reversible process. Enzymes can catalyse both forward and backward reactions. The final equilibrium mixture will, however, be the same, regardless of whether we supply the enzyme with substrate or product.

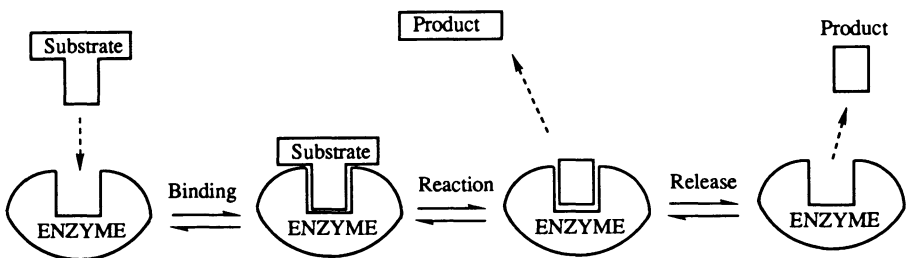

Fig. 4.4 Enzyme catalyst.

Substrates bind to and react at a specific area of the enzyme called the active site. The active site is usually quite a small part of the overall protein structure, but in considering the mechanism of enzymes we can make a useful simplification by concentrating on what happens at that site.

4.3 The active site of an enzyme

The active site of an enzyme (Fig. 4.5) is a 3D shape. It has to be on or near the surface of the enzyme if substrates are to reach it. However, the site could be a groove, hollow, or gully allowing the substrate to 'sink into' the enzyme.

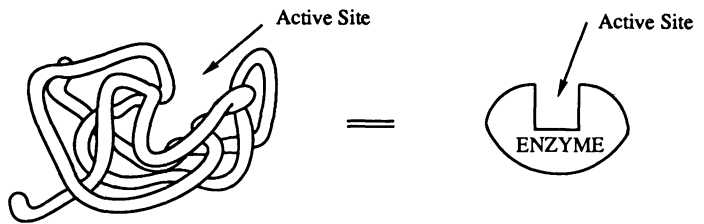

Fig. 4.5 The active site of an enzyme.

Because of the overall folding of the enzyme, the amino acid residues which are close together in the active site may be extremely far apart in the primary structure. For example, the important amino acids at the active site of lactate dehydrogenase are shown in Fig. 4.6. The numbers refer to their positions in the primary structure of the enzyme.

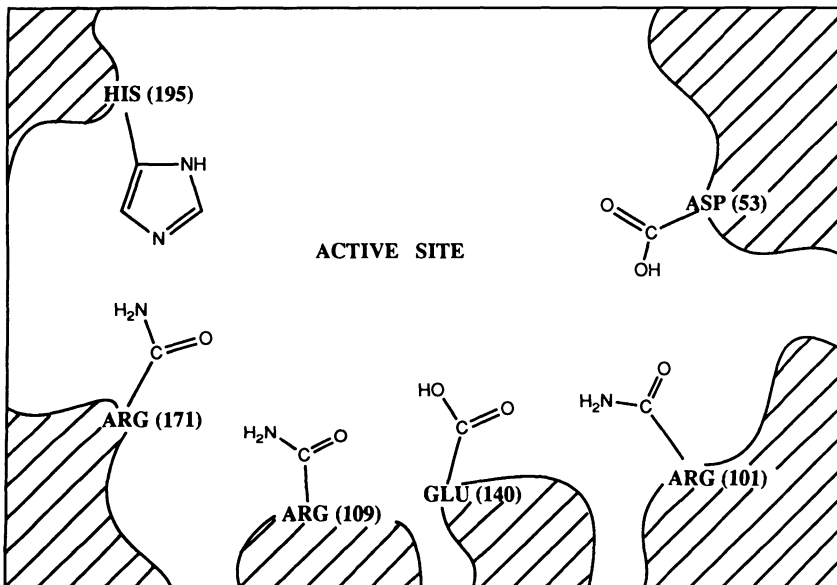

Fig. 4.6 The active site of lactate dehydrogenase.

The amino acids present in the active site play an important role in enzyme function and this can be demonstrated by comparing the primary structures of the same enzyme from different organisms. In such a study, we would find that the primary structure would differ from species to species as a result of mutations lasting over millions of years. The variability would be proportional to how far apart the organisms are on the evolutionary ladder and this is one method of determining such a relationship.

However, that does not concern us here. What does, is the fact that there are certain amino acids which remain constant, no matter the source of the enzyme. These are amino acids which are crucial to the enzyme's function and, as such, are often the amino acids which make up the active site. If one of these amino acids should be lost through mutation, the enzyme would become useless and an animal bearing this mutation would have a poor chance of survival. Thus, the mutation would not be preserved. (The only exception to this would be if the mutation either introduced an amino acid which could perform the same task as the original amino acid, or improved substrate binding.)

This consistency of active site amino acids can often help scientists determine which amino acids are present in an active site if this is not known already.

Amino acids present in the active site can have one of two roles.

1. Binding—the amino acid residue is involved in binding the substrate to the active site.
2. Catalytic—the amino acid is involved in the mechanism of the reaction.

We shall study these in turn.

4.4 Substrate binding at an active site

4.4.1 The binding forces

The forces which bind substrates to the active sites of enzymes are the same as those controlling the tertiary structure of enzymes—ionic, hydrogen, and van der Waals bonds. However, whereas ionic bonding plays a relatively minor role in protein tertiary structure compared to hydrogen bonding or van der Waals bonding, it can play a crucial role in the binding of a substrate to an active site—not too surprising since active sites are located on or near the surface of the enzyme.

Since we know the three bonding forces involved in substrate binding, it is possible to look at the structure of a substrate and postulate the probable interactions which it will have with its active site.

As an example, let us consider the substrate for lactate dehydrogenase—an enzyme which catalyses the reduction of pyruvic acid to lactic acid (Fig. 4.7).

If we look at the structure of pyruvic acid, we can propose three possible inter-

Fig. 4.7 Reduction of pyruvic acid to lactic acid.

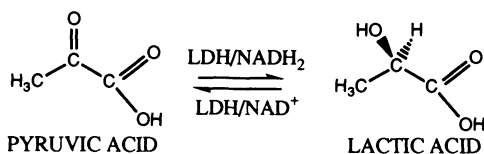

actions with which it might bind to its active site—an ionic interaction involving the ionized carboxylate group, a hydrogen bond involving the ketonic oxygen, and a van der Waals interaction involving the methyl group (Fig. 4.8). If these postulates are correct, then it means that there must be suitable amino acids at the active site to take part in these bonds. A lysine residue, serine residue, and phenylalanine residue would fit the bill respectively.

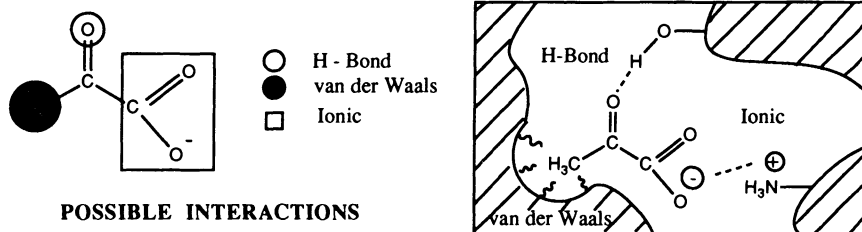

Fig. 4.8 Interactions between pyruvic acid and lactate dehydrogenase.

4.4.2 Competitive (reversible) inhibitors

Binding interactions between substrate and enzyme are clearly important. If there were no interactions holding the substrate to the active site, then the substrate would drift in and drift out again before there was a chance for it to react.

Therefore, the more binding interactions there are, the better the substrate will be bound, and the better the chance of reaction. But there is a catch! What would happen if a substrate bound so strongly to the active site that it was not released again (Fig. 4.9)?

The answer, of course, is that the enzyme would become 'clogged up' and would be

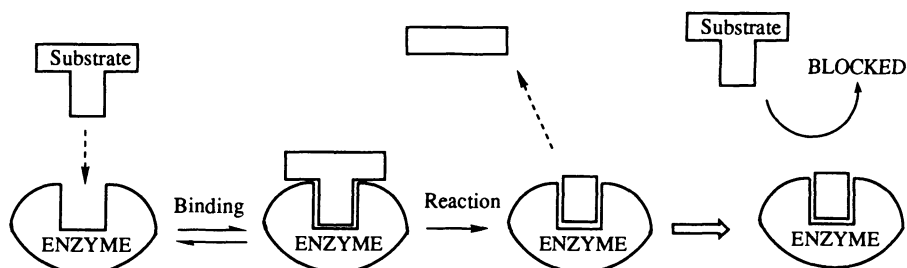

Fig. 4.9 Enzyme 'clogging'.

unable to accept any more substrate. Therefore, the bonding interactions between substrate and enzyme have to be properly balanced such that they are strong enough to keep the substrate(s) at the active site to allow reaction, but weak enough to allow the product(s) to depart. This bonding balancing act can be turned to great advantage by the medicinal chemist wishing to inhibit a particular enzyme or to switch it off altogether. A molecule can be designed which is similar to the natural substrate and can fit the active site, but which binds more strongly. It may not undergo any reaction when it is in the active site, but as long as it is there, it blocks access to the natural substrate and the enzymatic reaction stops (Fig 4.10). This is known as competitive inhibition since the drug is competing with the natural substrate for the active site.

The longer the inhibitor is present in the active site, the greater the inhibition. Therefore, if the medicinal chemist has a good idea which binding groups are present in an active site and where they are, a range of molecules can be designed with different inhibitory strengths.

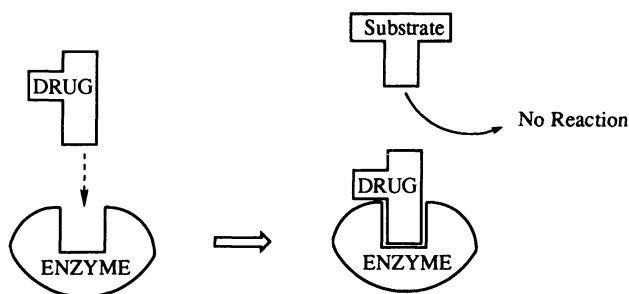

Fig. 4.10 Competitive inhibition.

Competitive inhibitors can generally be displaced by increasing the level of natural substrate. This feature has been useful in the treatment of accidental poisoning by antifreeze. The main constituent of antifreeze is ethylene glycol which is oxidized in a series of enzymatic reactions to oxalic acid (Fig. 4.11). It is the oxalic acid which is responsible for toxicity and if its synthesis can be blocked, recovery is possible.

The first step in this enzymatic process is the oxidation of ethylene glycol by alcohol dehydrogenase. Ethylene glycol is acting here as a substrate, but we can view it as a competitive inhibitor since it is competing with the natural substrate for the enzyme. If the levels of natural substrate are increased, it will compete far better with ethylene glycol and prevent it from reacting. Toxic oxalic acid would no longer be formed and the unreacted ethylene glycol would eventually be excreted from the body (Fig. 4.12).

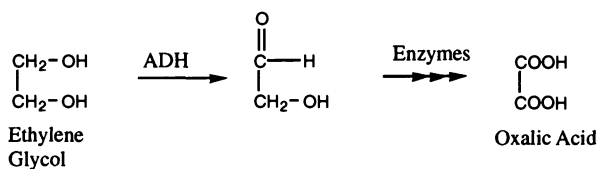
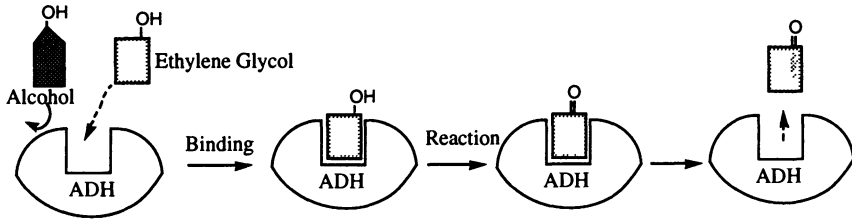

Fig. 4.11 Formation of oxalic acid from ethylene glycol.

OXIDATION OF ETHYLENE GLYCOL



BLOCKING WITH EXCESS ALCOHOL

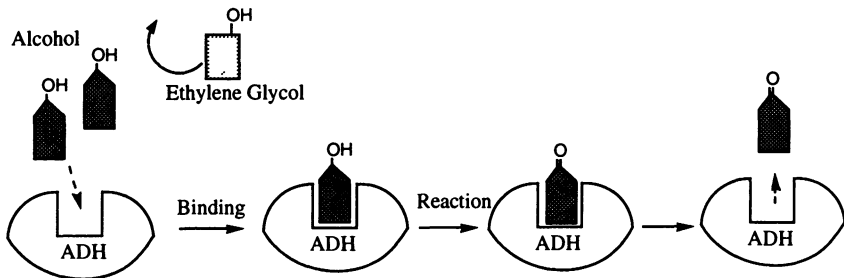

Fig. 4.12 Oxidation of ethylene glycol and blocking with excess alcohol.

The cure then is to administer high doses of the natural substrate—alcohol! Perhaps one of medicine's more acceptable cures?

There are many examples of useful drugs which act as competitive inhibitors. For example, the sulfonamides inhibit bacterial enzymes (Chapter 10), while anticholinesterases inhibit the mammalian enzyme acetylcholinesterase (Chapter 11). Many diuretics used to control blood pressure are competitive inhibitors.

4.4.3 Non-competitive (irreversible) inhibitors

To stop an enzyme altogether, the chemist can design a drug which binds irreversibly to the active site and blocks it permanently. This would be a non-competitive form of inhibition since increased levels of natural substrate would not be able to budge the unwanted squatter. The most effective irreversible inhibitors are those which can react with an amino acid at the active site to form a covalent bond. Amino acids such as serine and cysteine which bear nucleophilic residues (OH and SH respectively) are common inhabitants of enzyme active sites since they are frequently involved in the mechanism of the enzyme reaction (see later). By designing an electrophilic drug which would fit the active site, it is possible to alkylate these particular groups and hence permanently clog up the active site (Fig. 4.13).

The nerve gases (Chapter 11) are irreversible inhibitors of mammalian enzymes and

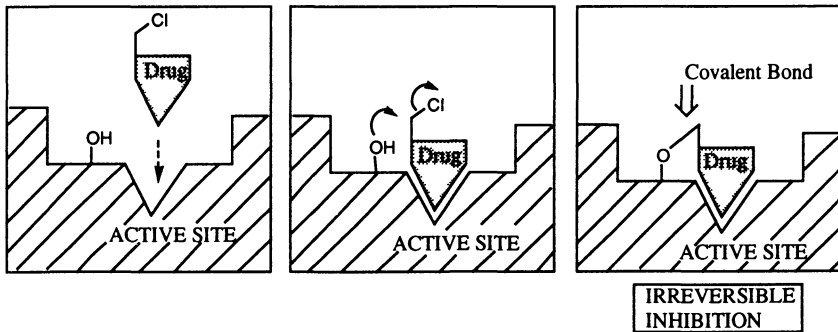

Fig. 4.13 Irreversible inhibition.

are therefore highly toxic. In the same way, penicillin (Chapter 10) is highly toxic to bacteria.

4.4.4 Non-competitive, reversible (allosteric) inhibitors

So far we have discussed inhibitors which bind to the active site and prevent the natural substrate from binding. We would therefore expect these inhibitors to have some sort of structural similarity to the natural substrate. We would also expect reversible inhibitors to be displaced by increased levels of natural substrate.

However, there are many enzyme inhibitors which appear to have no structural similarity to the natural substrate. Furthermore, increasing the amount of natural substrate has no effect on the inhibition. Such inhibitors are therefore non-competitive inhibitors, but unlike the non-competitive inhibitors mentioned above, the inhibition is reversible.

Non-competitive or allosteric inhibitors bind to a different region of the enzyme and are therefore not competing with the substrate for the active site. However, since binding is taking place, a moulding process takes place (Fig. 4.14) which causes the enzyme to change shape. If that change in shape hides the active site, then the substrate can no longer react.

Adding more substrate will not reverse the situation, but that does not mean that the inhibition is irreversible. Since the inhibitor uses non-covalent bonds to bind to the allosteric binding site, it will eventually depart in its own good time.

But why should there be this other binding site?

The answer is that allosteric binding sites are important in the control of enzymes. A biosynthetic pathway to a particular product involves a series of enzymes, all working efficiently to convert raw materials into final product. Eventually, the cell will have enough of the required material and will want to stop production. Therefore, there has to be some sort of control which says enough is enough. The most common control mechanism is one known as feedback control, where the final

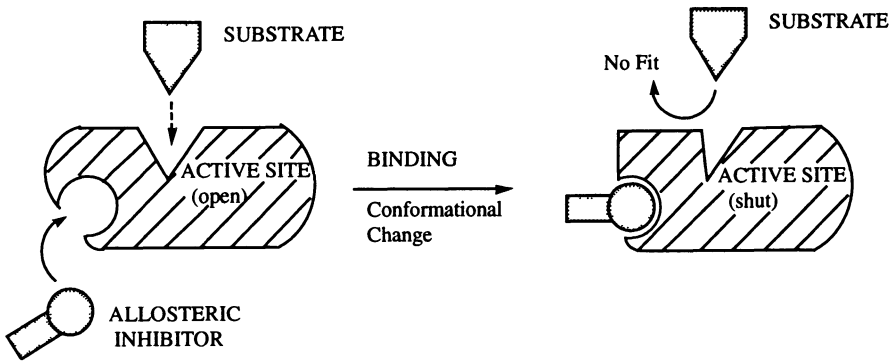

Fig. 4.14 Non-competitive, reversible (allosteric) inhibition.

product controls its own synthesis. It can do this by inhibiting the first enzyme in the biochemical pathway (Fig. 4.15). Therefore, when there are low levels of final product in the cell, the first enzyme in the pathway is not inhibited and works normally. As the levels of final product increase, more and more of the enzyme is blocked and the rate of synthesis drops off in a graded fashion.

We might wonder why the final product inhibits the enzyme at an allosteric site and not the active site itself. There are two explanations for this.

First of all, the final product has undergone many transformations since the original starting material and is no longer 'recognized' by the active site. It must therefore bind elsewhere on the enzyme.

Secondly, binding to the active site itself would not be a very efficient method of feedback control, since it would then have to compete with the starting material. If levels of the latter increased, then the inhibitor would be displaced and feedback control would fail.

An enzyme under feedback control offers the medicinal chemist an extra option in designing an inhibitor. The chemist can not only design drugs which are based on the structure of the substrate and which bind directly to the active site, but can also design drugs based on the structure of the final overall product and which bind to the allosteric binding site.

The drug 6-mercaptopurine, used in the treatment of leukaemia (Fig. 4.16), is

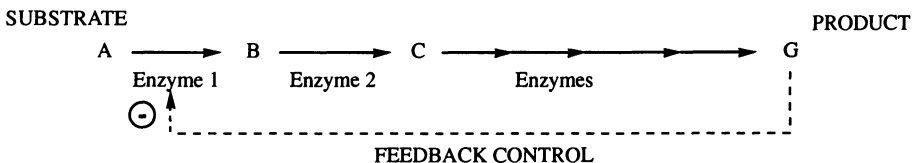

Fig. 4.15 Control of enzymes.

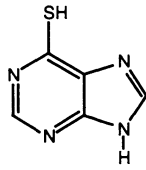

Fig. 4.16 6-Mercaptopurine.

an example of an allosteric inhibitor. It inhibits the first enzyme involved in the synthesis of purines and therefore blocks purine synthesis. This in turn blocks DNA synthesis.

4.5 *The catalytic role of enzymes*

We now move on to consider the mechanism of enzymes, and how they catalyse reactions.

In general, enzymes catalyse reactions by providing the following:

- (1) binding interactions
- (2) acid/base catalysis
- (3) nucleophilic groups

4.5.1 Binding interactions

As mentioned previously, the rate of a reaction is increased if the energy of the transition state is lowered. This results from the bonding interactions between substrate and enzyme.

In the past, it was thought that a substrate fitted its active site in a similar way to a key fitting a lock. Both the enzyme and the substrate were seen as rigid structures with the substrate (the key) fitting perfectly into the active site (the lock) (Fig. 4.17). However, such a scenario does not explain how some enzymes can catalyse a reaction on a range of different substrates. It implies instead that an enzyme has an optimum substrate which fits it perfectly and which can be catalysed very efficiently, whereas all other substrates are catalysed less efficiently. Since this is not the case, the lock and key analogy is invalid.

It is now believed that the substrate is nearly a good fit for the active site but not a perfect fit. It is thought instead that the substrate enters the active site and forces it to change shape—a kind of moulding process. This theory is known as Koshland's Theory of Induced Fit since the substrate induces the active site to take up the ideal shape to accommodate it (Fig. 4.17).

For example, a substrate such as pyruvic acid might interact with its active site via one hydrogen bond, one ionic bond, and one van der Waals interaction. However, the fit might not be quite right and the three bonding interactions might be a bit too long

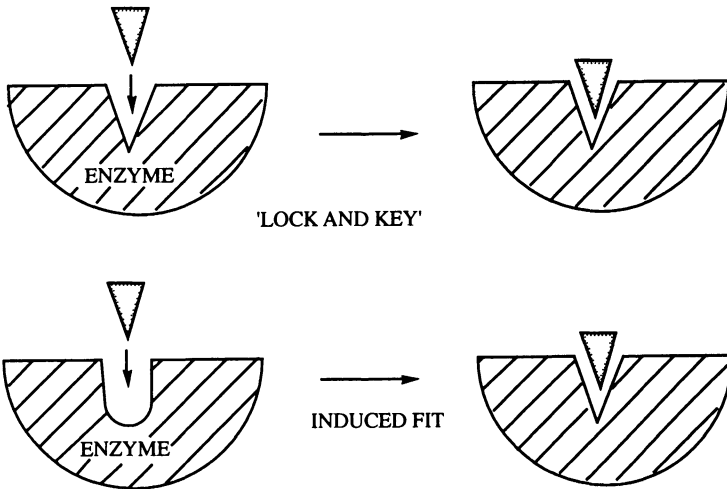

Fig. 4.17 Bonding interactions between substrate and enzyme.

to be perfect. In order to maximize the strength of these bonds, the enzyme would have to change shape so that the amino acid residues involved in the binding move closer to the substrate (Fig. 4.18).

This theory of induced fit helps to explain why enzymes can catalyse a wide range of substrates. Each substrate induces the active site into a shape which is ideal for it, and as long as the moulding process does not distort the active site too much, such that the reaction mechanism proves impossible, then reaction can proceed.

But note this. The substrate is not just a passive spectator to the moulding process going on around it. As the enzyme changes shape to maximize bonding interactions, the same thing is going to happen to the substrate. It too will alter shape. Bond rotation may occur to fix the substrate in a particular conformation—not necessarily the most stable conformation. Bonds may even be stretched and weakened. Consequently, this moulding process designed to maximize binding interactions may force the substrate into the ideal conformation for the reaction to follow (i.e. the transition state) and may also weaken the very bonds which have to be broken.

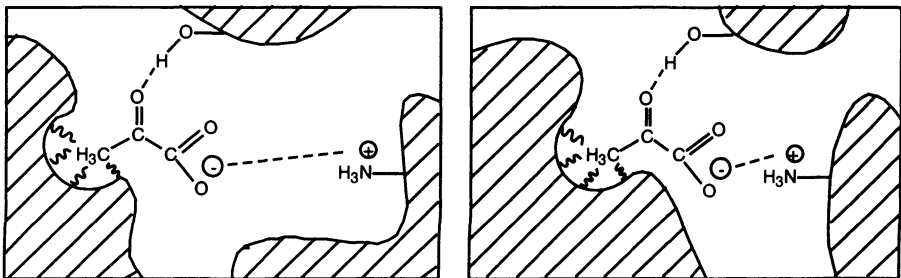

Fig. 4.18 Example of induced fit.

Once bound to an active site, the substrate is now held ready for the reaction to follow. Binding has fixed the 'victim' so that it cannot evade attack and this same binding has weakened its defences (bonds) so that reaction is easier (lower activation energy).

4.5.2 Acid/base catalysis

Usually acid/base catalysis is provided by the amino acid histidine. Histidine is a weak base and can easily equilibrate between its protonated form and its free base form (Fig. 4.19). In doing so, it can act as a proton 'bank'; that is, it has the capability to accept and donate protons in the reaction mechanism. This is important since active sites are frequently hydrophobic and will therefore have a low concentration of water and an even lower concentration of protons.

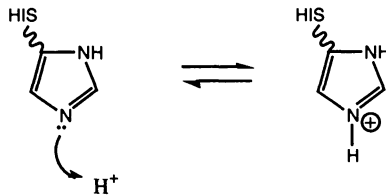

Fig. 4.19 Histidine.

4.5.3 Nucleophilic groups

The amino acids serine and cysteine are common inhabitants of active sites. These amino acids have nucleophilic residues (OH and SH respectively) which are able to participate in the reaction mechanism. They do this by reacting with the substrate to form intermediates which would not be formed in the uncatalysed reaction. These intermediates offer an alternative reaction pathway which may avoid a high-energy transition state and hence increase the rate of the reaction.

Normally, an alcoholic group such as that on serine is not a good nucleophile. However, there is usually a histidine residue close by to catalyse the reaction. For example, the mechanism by which chymotrypsin hydrolyses peptide bonds is shown in Fig. 4.20.

The presence of a nucleophilic serine residue means that water is not required in the initial stages of the mechanism. This is important since water is a poor nucleophile and may also find it difficult to penetrate a hydrophobic active site. Secondly, a water molecule would have to drift into the active site, and search out the carboxyl group before it could attack it. This would be something similar to a game of blind man's buff. The enzyme, on the other hand, can provide a serine OH group, positioned in exactly the right spot to react with the substrate. Therefore, the nucleophile has no need to search for its substrate. The substrate has been delivered to it.

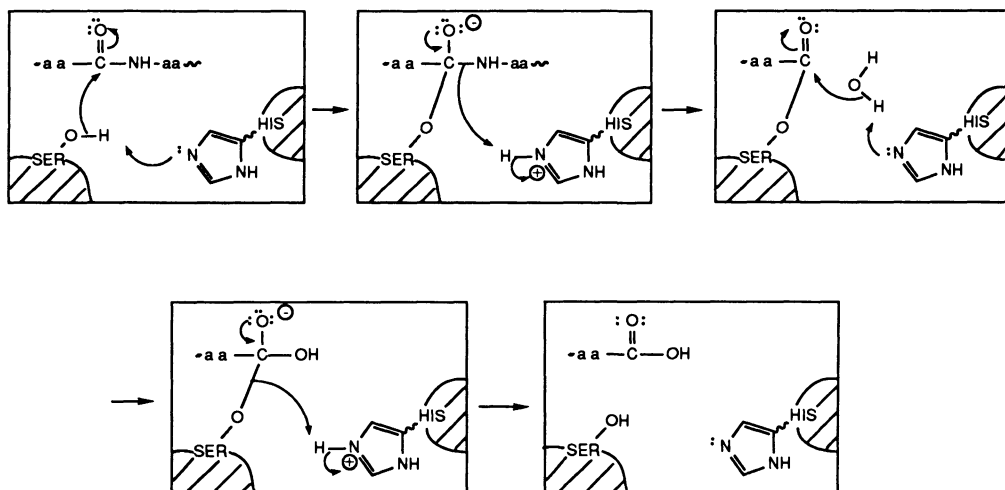

Fig. 4.20 Hydrolysis of peptide bonds by chymotrypsin.

Water is required eventually to hydrolyse the acyl group attached to the serine residue. However, this is a much easier step than the hydrolysis of a peptide link since esters are more reactive than amides. Furthermore, the hydrolysis of the peptide link means that one half of the peptide can drift away from the active site and leave room for a water molecule to enter.

As far as the medicinal chemist is concerned, an understanding of the mechanism can help in the design of more powerful inhibitors.

First of all, if the mechanism is known, it is possible to design antagonists which bind so strongly to the active site by non-covalent forces that they are effectively irreversible inhibitors—a bit like inviting the mother-in-law for dinner and finding her moving in on a permanent basis.

The logic is as follows. We have already seen that the enzyme alters the shape and the bond lengths of the substrate such that it effectively converts it to the transition state for the reaction. Therefore, if the enzyme was given a compound which was already the same shape as the transition state, then that compound should be an ideal binding group for the active site, and should bind very efficiently. If the compound was unable to react further, then the enzyme would be strongly inhibited.

Such compounds are known as transition-state analogues.

The beauty of the tactic is that it can be used effectively against enzyme reactions involving two substrates. With such enzymes, inhibitors based on one substrate or the other could be designed, but neither will be as good as an inhibitor based on a transition-state analogue where the two are linked together. The latter is bound to have more bonding interactions.

One interesting example of a transition-state inhibitor is the drug 5-fluorouracil

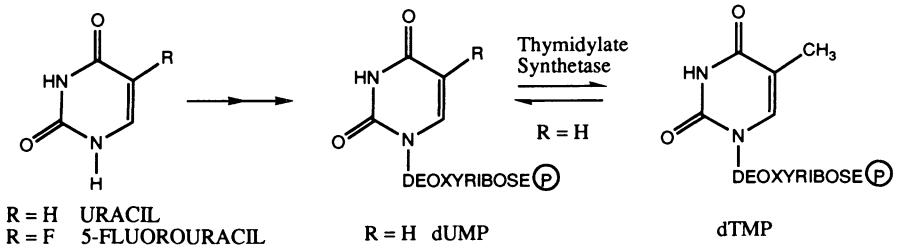

Fig. 4.21 Biosynthesis of dTMP.

(Fig. 4.21)—used to treat breast cancer and skin cancer. The target enzyme is thymidylate synthetase which catalyses the conversion of 2'-deoxyuridylic acid to dTMP (Figs 4.21 and 4.22).

5-Fluorouracil is not the transition-state analogue itself. It is converted in the body to the fluorinated analogue of 2'-deoxyuridylic acid which then combines with a second substrate (tetrahydrofolate) to form a transition-state analogue *in situ*. Up until this point, nothing unusual has happened and the reaction mechanism has been proceeding normally. The tetrahydrofolate has formed a covalent bond to the uracil skeleton via the methylene unit which is to be transferred. At this stage, the loss of a proton from the 5-position is required. However, 5-fluorouracil has a fluorine atom at

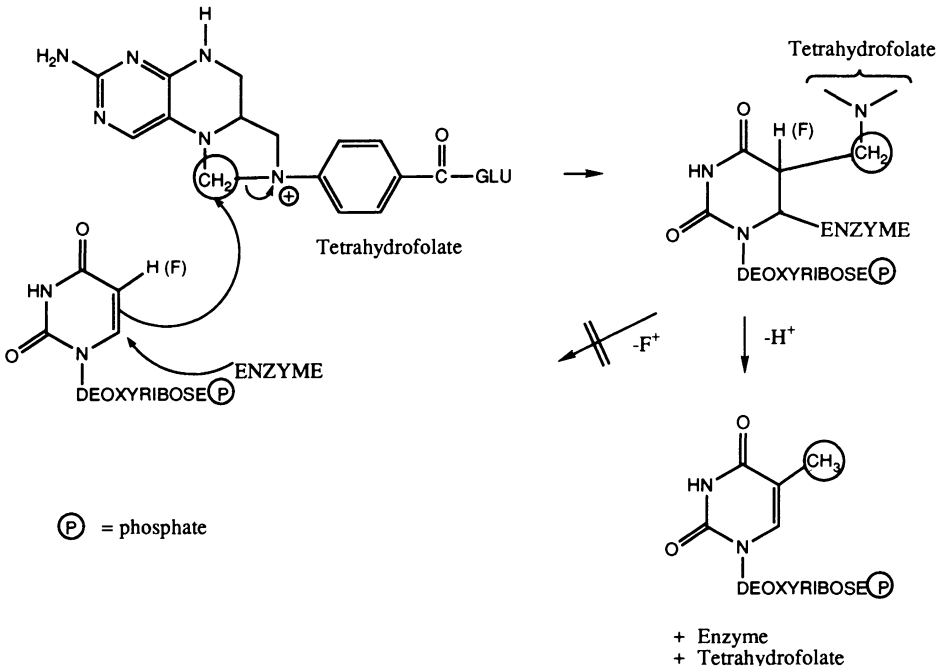

Fig. 4.22 Use of 5-fluorouracil as a transition-state inhibitor.

that position instead of a hydrogen. Further reaction is impossible since it would require fluorine to leave as a positive ion. As far as the enzyme is concerned, the situation moves from bad to worse. Not only does it find it impossible to complete its task, it finds it impossible to get rid of the logjam. As part of the mechanism, the uracil skeleton is covalently linked to the enzyme. This covalent bond would normally be cleaved to release the thymine product, but since the mechanism has jammed, this now proves impossible and the complex remains irreversibly bound to the active site. Synthesis of thymidine is terminated, which in turn stops the synthesis of DNA. Result: replication and cell division are blocked.

5-Fluorouracil is a particularly useful drug for the treatment of skin cancer since it shows a high level of selectivity for cancer cells over normal skin cells.

In the above example, the enzyme accepted the drug as a bona fide visitor, only to find that it gained an awkward squatter impossible to move. Other apparently harmless visitors can turn into lethal assassins which actively attack the enzyme. Once again, it is the enzyme mechanism itself which causes the transformation. One example of this is provided by the irreversible inhibition of the enzyme alanine transaminase by trifluoroalanine (Fig. 4.23).

The normal mechanism for the transamination reaction is shown in Fig. 4.24 (R=H) and involves the condensation of alanine and pyridoxal phosphate to give an imine. A proton is lost from the imine to give a dihydropyridine intermediate. This reaction is catalysed by a basic amino acid provided by the enzyme as well as the electron withdrawing effects of the protonated pyridine ring. The dihydropyridine structure now formed is hydrolysed to give the products.

Trifluoroalanine contains three fluorine atoms which are very similar in size to the hydrogen atoms in alanine. The molecule is therefore able to fit into the active site of the enzyme and take alanine's place. The reaction mechanism proceeds as before to give the dihydropyridine intermediate. However, at this stage, an alternative mechan-

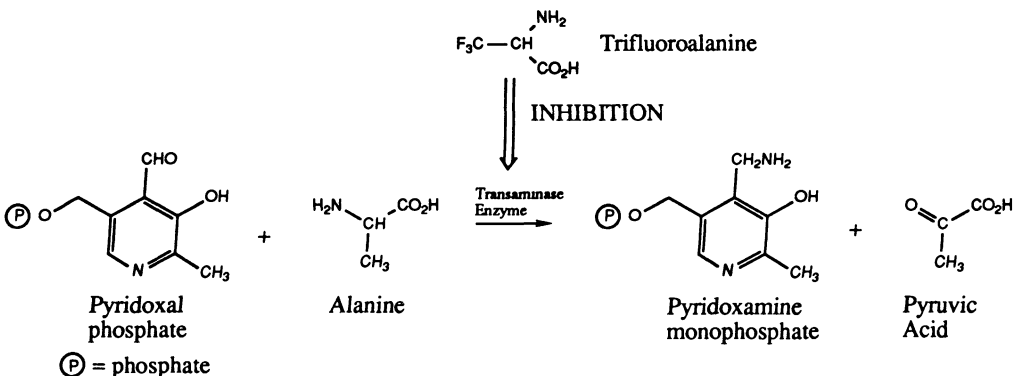

Fig. 4.23 Irreversible inhibition of the enzyme alanine transaminase.

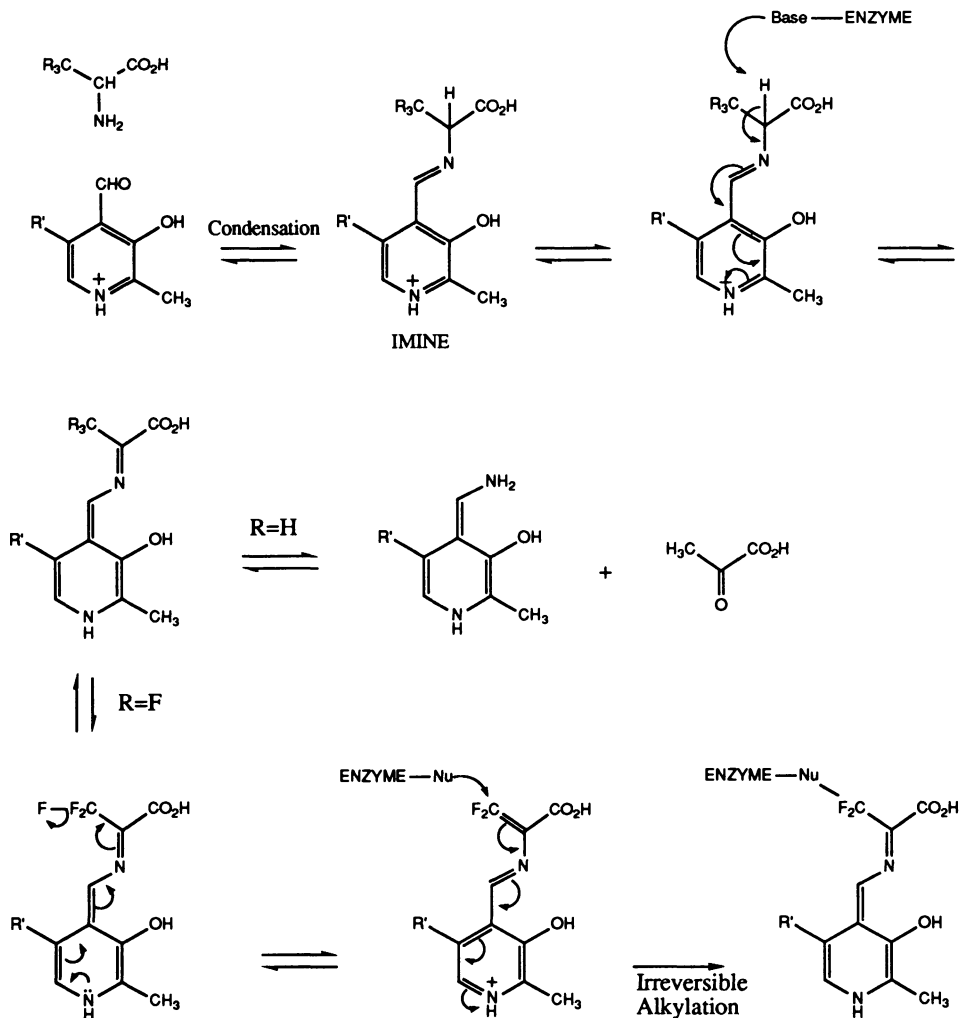

Fig. 4.24 Mechanism for the transamination reaction and its inhibition.

ism now becomes possible ($R=F$). A fluoride atom is electronegative and can therefore act as a leaving group. When this happens, a powerful alkylating agent is formed which can irreversibly alkylate any nucleophilic group present in the enzyme's active site. A covalent bond is now formed and the active site is unable to accept further substrate. As a result, the enzyme is irreversibly inhibited.

Drugs which operate in this way are often called suicide substrates since the enzyme is committing suicide by reacting with them. The great advantage of this approach is that the alkylating agent is generated at the site where it is meant to act and is therefore highly selective for the target enzyme. If the alkylating group had not been disguised in this way, the drug would have alkylated the first nucleophilic group it

met in the body and would have shown little or no selectivity. (The uses of alkylating agents and the problems associated with them are also discussed in Chapter 6.)

Unfortunately, no useful therapeutic drug has been designed by this approach so far. Inhibiting the transaminase enzyme has no medicinal use since the enzyme is crucial to mammalian biochemistry and inhibiting it would be toxic to the host. The main use for suicide substrates has been in labelling specific enzymes. The substrates can be labelled with radioactivity and reacted with their target enzyme in order to locate the enzyme in tissue preparations.

However, the suicide substrate approach may yet prove successful in medicine if used against enzymes which are unique to 'foreign invaders' such as bacteria, protozoa, and fungi.

4.6 Medicinal uses of enzyme inhibitors

Inhibitors of enzymes are most successful in the war against infection. If an enzyme is crucial to a microorganism, then switching it off will clearly kill the cell or prevent it from growing. Of course, the enzyme chosen has to be one which is not present in our own bodies. Fortunately, there are significant biochemical differences between bacterial cells and our own to permit this approach to work.

Nature, of course, is well ahead in this game. The fungal metabolite penicillin enters bacterial cells and 'fools its way' into the active site of an enzyme which is crucial to the construction of the bacterial cell wall. It then reacts through the normal mechanism and in doing so forms a stable covalent bond to the enzyme. The enzyme can no longer accept the normal substrate, construction of the cell wall ceases and the cell dies.

Chapter 10 covers antibacterial agents such as the sulfonamides, penicillins, and cephalosporins all of which act by inhibiting enzymes.

Chapter 11 considers agents known as anticholinesterases which inhibit the enzyme responsible for the hydrolysis of the neurotransmitter acetylcholine.

5 ■ Drug action at receptors

5.1 *The receptor role*

Enzymes are one major target for drugs. Receptors are another. Drugs which interact with receptors are amongst the most important in medicine and provide treatment for ailments such as pain, depression, Parkinson's disease, psychosis, heart failure, asthma, and many other problems.

What are these receptors and what do they do?

Cells are all individual, but in a complex organism such as ourselves, they have to 'get along' with their neighbours. There has to be some sort of communication system. After all, it would be pointless if individual heart cells were to contract at different times. The heart would then be a wobbly jelly and totally useless in its function as a pump. Communication is essential to ensure that all heart muscle cells contract at the same time. The same holds true for all the body's organs and functions. Communication is essential if the body is to operate in a coordinated and controlled fashion.

Control and communication come primarily from the brain and spinal column (the central nervous system—CNS) which receives and sends messages via a vast network of nerves (Fig. 5.1). The detailed mechanism by which nerves transmit messages along their length need not concern us here (see Appendix 2). It is sufficient for our purposes to think of the message as being an electrical 'pulse' which travels down the nerve cell towards the target, whether that be a muscle cell or another nerve. If that was all there was to it, it would be difficult to imagine how drugs could affect this communication system. However, there is one important feature of this system which is crucial to our understanding of drug action. The nerves do not connect directly to their target cells. They stop just short of the cell surface. The distance is minute, about 100 Å, but it is a space which the electrical impulse is unable to 'jump'.

Therefore, there has to be a way of carrying the message across the gap between the nerve ending and the cell. The problem is solved by the release of a chemical messenger (neurotransmitter) from the nerve cell (Fig. 5.2). Once released, this

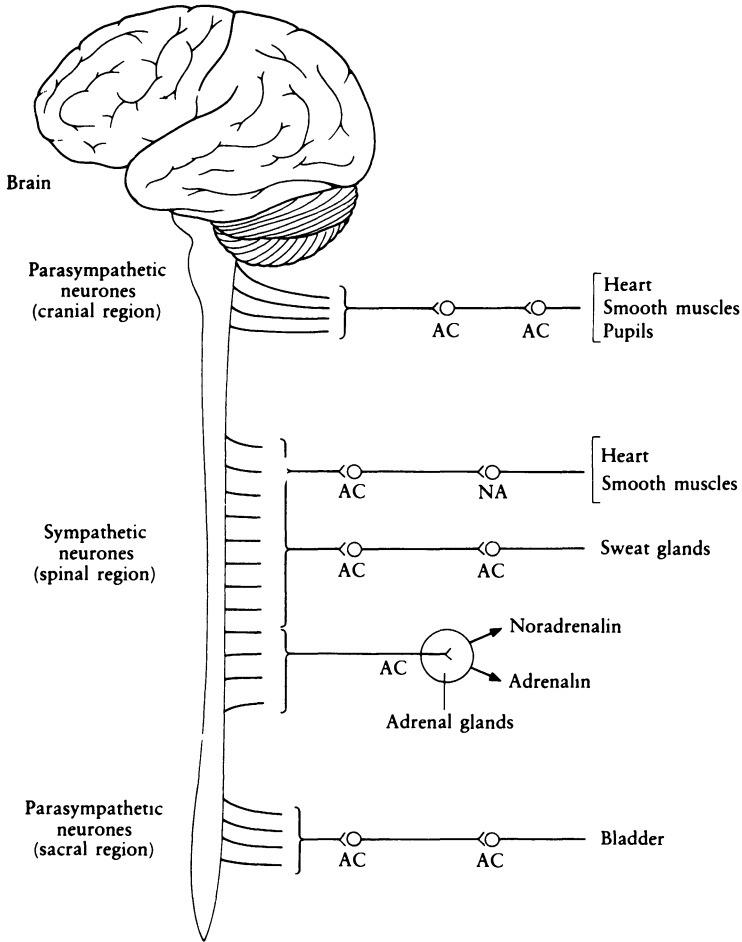

Fig. 5.1 The central nervous system. Taken from J. Mann, *Murder, magic, and medicine*, Oxford University Press (1992), with permission.

chemical messenger can diffuse across the gap to the target cell, where it can bind and interact with a specific protein (receptor) embedded in the cell membrane. This process of binding leads to a series or cascade of secondary effects which result either in a flow of ions across the cell membrane or in the switching on (or off) of enzymes inside the target cell. A biological response then results, such as the contraction of a muscle cell or the activation of fatty acid metabolism in a fat cell.

We shall consider these secondary effects and how they result in a biological action at a later stage, but for the moment the important thing to note is that the communication system depends crucially on a chemical messenger. Since a chemical process is

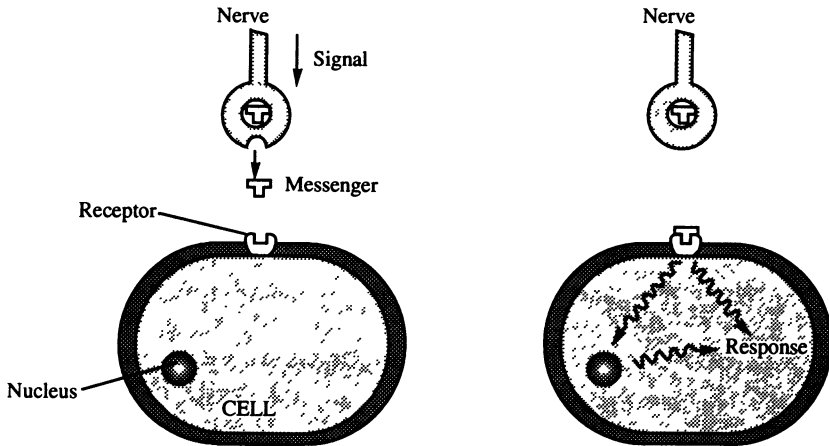

Fig. 5.2 Neurotransmitter action.

involved, it should be possible for other chemicals (drugs) to interfere or to take part in the process.

5.2 Neurotransmitters

Let us now look a bit closer at neurotransmitters and receptors, and consider first the messengers. What are they?

There are a large variety of messengers, many of them quite simple molecules. Neurotransmitters include such compounds as acetylcholine, noradrenaline, dopamine, γ -aminobutanoic acid (GABA), serotonin, 5-hydroxytryptophan, and even glycine (Fig. 5.3).

In general, a nerve releases only one type of neurotransmitter¹ and the receptor which awaits it on the target cell will be specific for that messenger. However, that does not mean that the target cell has only one type of receptor protein. Each target cell has a large number of nerves communicating with it and they do not all use the same neurotransmitter (Fig. 5.4). Therefore, the target cell will have other types of receptors specific for those other neurotransmitters. It may also have receptors waiting to receive messages from chemical messengers which have longer distances to

¹ In the past, it has been assumed that only one type of neurotransmitter is released from any one type of nerve cell. This is now known not to be true. Certainly as far as the amine neurotransmitters (i.e. acetylcholine, noradrenaline, glycine, serotonin, GABA, and dopamine) are concerned, it is generally true that only one of these messengers is released by any one nerve cell.

However, there is now a growing list of peptide cotransmitter substances which appear to be released from nerve cells along with the above neurotransmitters. For example, somatostatin, cholecystokinin, vasointestinal peptide, substance P, and neurotensin have all been identified as cotransmitters of acetylcholine in a variety of situations.

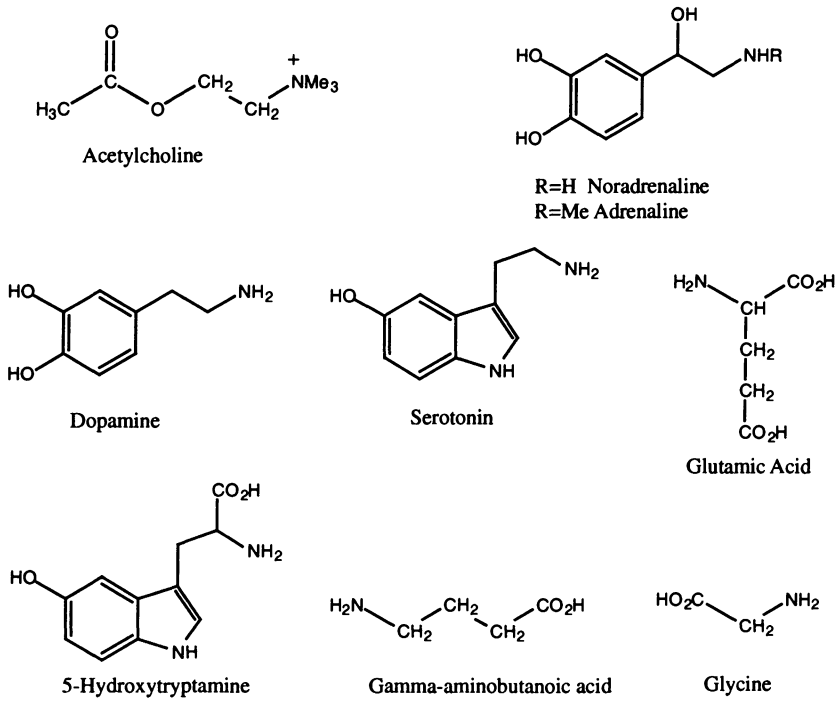

Fig. 5.3 Examples of neurotransmitters.

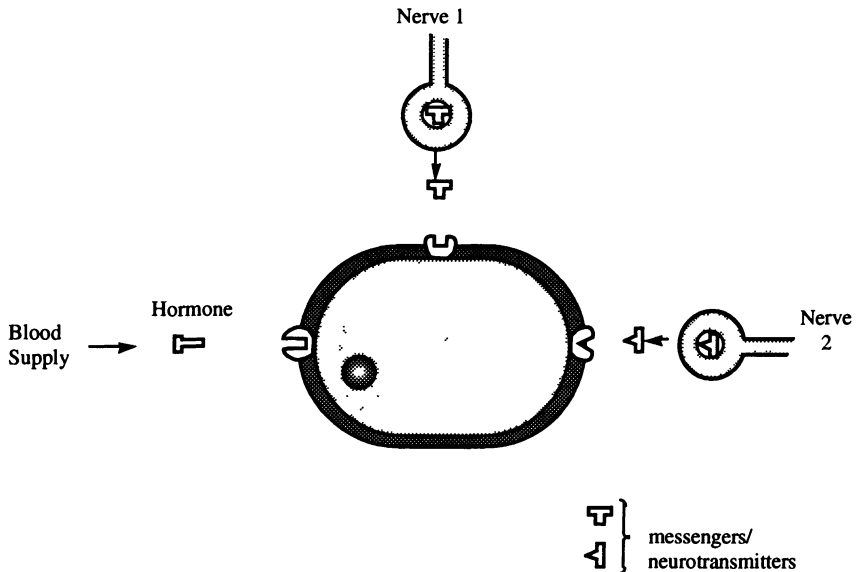

Fig. 5.4 Target cell containing receptors specific to each type of messenger.

travel. These are the hormones released into the circulatory system by various glands in the body. The best known example of a hormone is adrenaline. When danger or exercise is anticipated, the adrenal medulla gland releases adrenaline into the bloodstream where it is carried round the body, preparing it for violent exercise.

Hormones and neurotransmitters can be distinguished by the route they travel and by the way they are released, but their action when they reach the target cell is the same. They both interact with a receptor and a message is received. The cell responds to that message, adjusts its internal chemistry accordingly and a biological response results.

Communication is clearly essential for the normal working of the human body, and if the communication should become faulty then it could lead to such ailments as depression, heart problems, schizophrenia, muscle fatigue, and many other problems. What sort of things *could* go wrong?

One problem would be if too many messengers were released. The target cell could start to 'overheat'. Alternatively, if too few messengers were sent out, the cell could become 'sluggish'. It is at this point that drugs can play a role by either acting as replacement messengers (if there is a lack of the body's own messengers), or by blocking the receptors for the natural messengers (if there are too many host messengers). Drugs of the former type are known as agonists. Those of the latter type are known as antagonists.

What determines whether a drug is an agonist or an antagonist and is it possible to predict whether a new drug will act as one or the other?

In order to answer that, we have to move down once more to the molecular level and understand what happens when a small molecule such as a drug or a neurotransmitter interacts with a receptor protein.

Let us first look at what happens when one of the body's own messengers (neurotransmitters or hormones) interacts with its receptor.

5.3 Receptors

A receptor is a protein molecule embedded within the cell membrane with part of its structure facing the outside of the cell. The protein surface will be a complicated shape containing hollows, ravines, and ridges, and somewhere amidst this complicated geography, there will be an area which has the correct shape to accept the incoming messenger. This area is known as the binding site and is analogous to the active site of an enzyme. When the chemical messenger fits into this site, it 'switches on' the receptor molecule and a message is received (Fig. 5.5).

However, there is an important difference between enzymes and receptors in that the chemical messenger does not undergo a chemical reaction. It fits into the binding site of the receptor protein, passes on its message and then leaves unchanged. If no

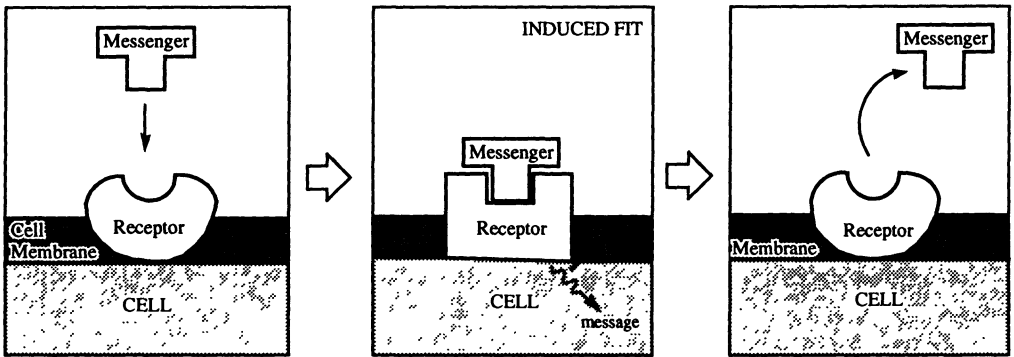

Fig. 5.5 Binding of a messenger to a receptor.

reaction takes place, what has happened? How does the chemical messenger tell the receptor its message and how is this message conveyed to the cell?

5.4 How does the message get received?

It all has to do with shape. Put simply, the messenger binds to the receptor and induces it to change shape. This change subsequently affects other components of the cell membrane and leads to a biological effect.

There are two main components involved:

- (1) ion channels
- (2) membrane-bound enzymes

5.4.1 Ion channels and their control

Some neurotransmitters operate by controlling ion channels. What are these ion channels and why are they necessary? Let us look again at the structure of the cell membrane.

As described in Chapter 2, the membrane is made up of a bilayer of fatty molecules, and so the middle of the cell membrane is 'fatty' and hydrophobic. Such a barrier makes it difficult for polar molecules or ions to move in or out of the cell. Yet it is important that these species should cross. For example, the movement of sodium and potassium ions across the membrane is crucial to the function of nerves (Appendix 2), while polar compounds such as amino acids are needed by the cell to build essential macromolecules such as proteins. It seems an intractable problem, but once again the ubiquitous proteins come up with the answer.

There are proteins present in the cell membrane which can smuggle polar molecules such as amino acids across the unfriendly medium of the cell membrane. These so-

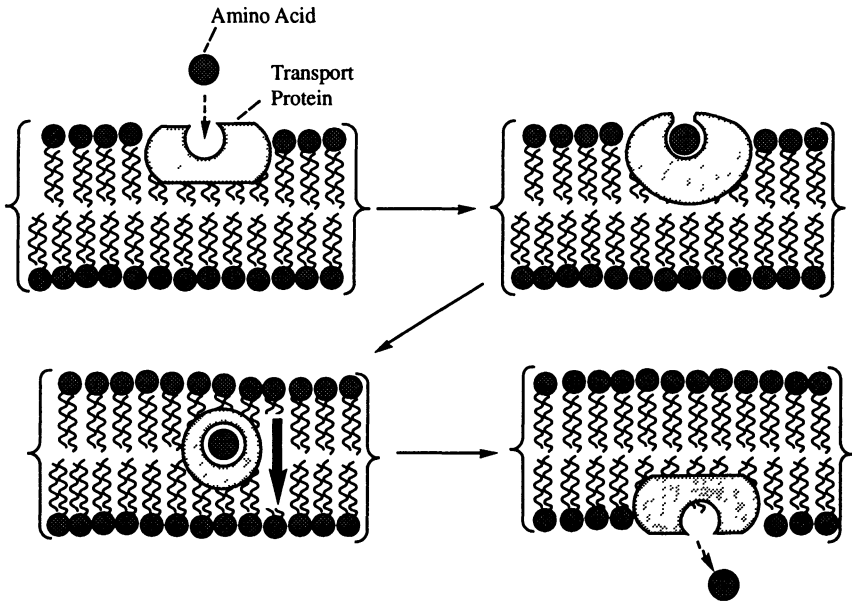

Fig. 5.6 Transport proteins.

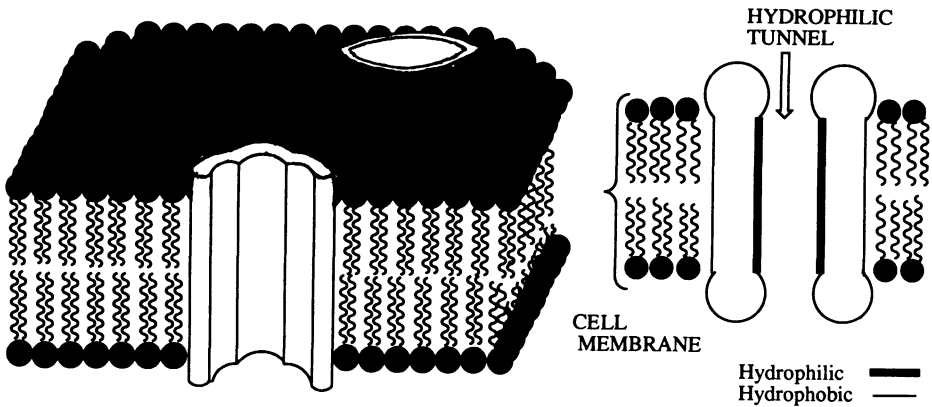

Fig. 5.7 Ion channel protein structure.

called 'transport proteins' bind the polar molecule at the outside of the cell, 'wrap it up' and ferry it across the membrane to release it on the other side (Fig. 5.6).

The ions, meanwhile, are assisted by a protein structure called an ion channel (Fig. 5.7). This structure traverses the cell membrane and consists of a protein complex made up of several subunits. The centre of the complex is hollow and is lined with polar amino acids to give a hydrophilic pore.

Ions can now cross the fatty barrier of the cell membrane by moving through these

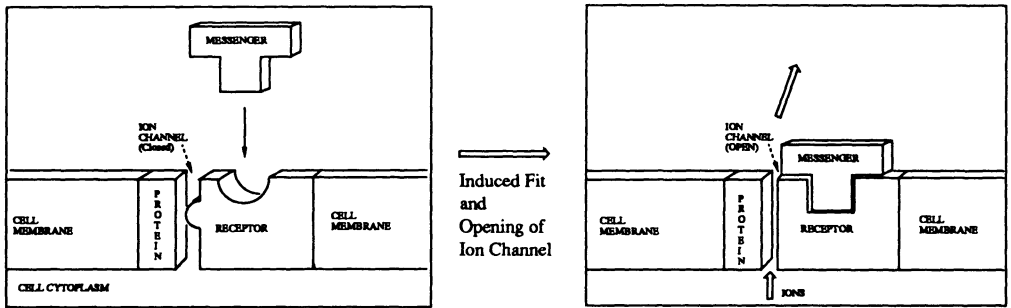

Fig. 5.8 Lock-gate mechanism for opening ion channels.

hydrophilic channels or tunnels. But there has to be some control. In other words, there has to be a 'lock-gate' which can be opened or closed as required. It makes sense that the control of this lock-gate should be associated with the message received from a neurotransmitter or hormone.

One possible mechanism is that the receptor protein itself is the lock-gate which seals the ion channel. When a chemical messenger binds to the receptor, the resulting change of shape could pull the lock-gate open and allow ions to pass (Fig. 5.8).

It is worth emphasizing one important point at this stage. If the messenger is to make the receptor protein change shape, then the binding site cannot be a 'negative image' of the messenger molecule. This must be true, otherwise how could a change of shape result? Therefore, when the binding site receives its messenger it is 'moulded' into the correct shape for the ideal fit. (This theory of an induced fit has already been described in the previous chapter to explain the interaction between enzymes and their substrates.)

The operation of an ion channel helps to explain why the relatively small number of neurotransmitter molecules released by a nerve is able to have such a significant biological effect on the target cell. By opening a few ion channels, several thousand ions are mobilized for each neurotransmitter molecule involved.

5.4.2 Membrane-bound enzymes—activation/deactivation

This is the second possible mechanism by which neurotransmitters can pass on their message to a cell. The receptor protein is situated on the outer surface of the cell membrane as before. This time, however, it is associated with a protein or enzyme situated at the inner surface of the membrane. When the receptor protein binds to its neurotransmitter, it changes shape and this forces the enzyme to change shape as well. Such a change might then reveal an active site in the enzyme which had previously been concealed, and thus start a new reaction within the cell (Fig. 5.9).

Alternatively, the membrane-bound enzyme may be working normally and the

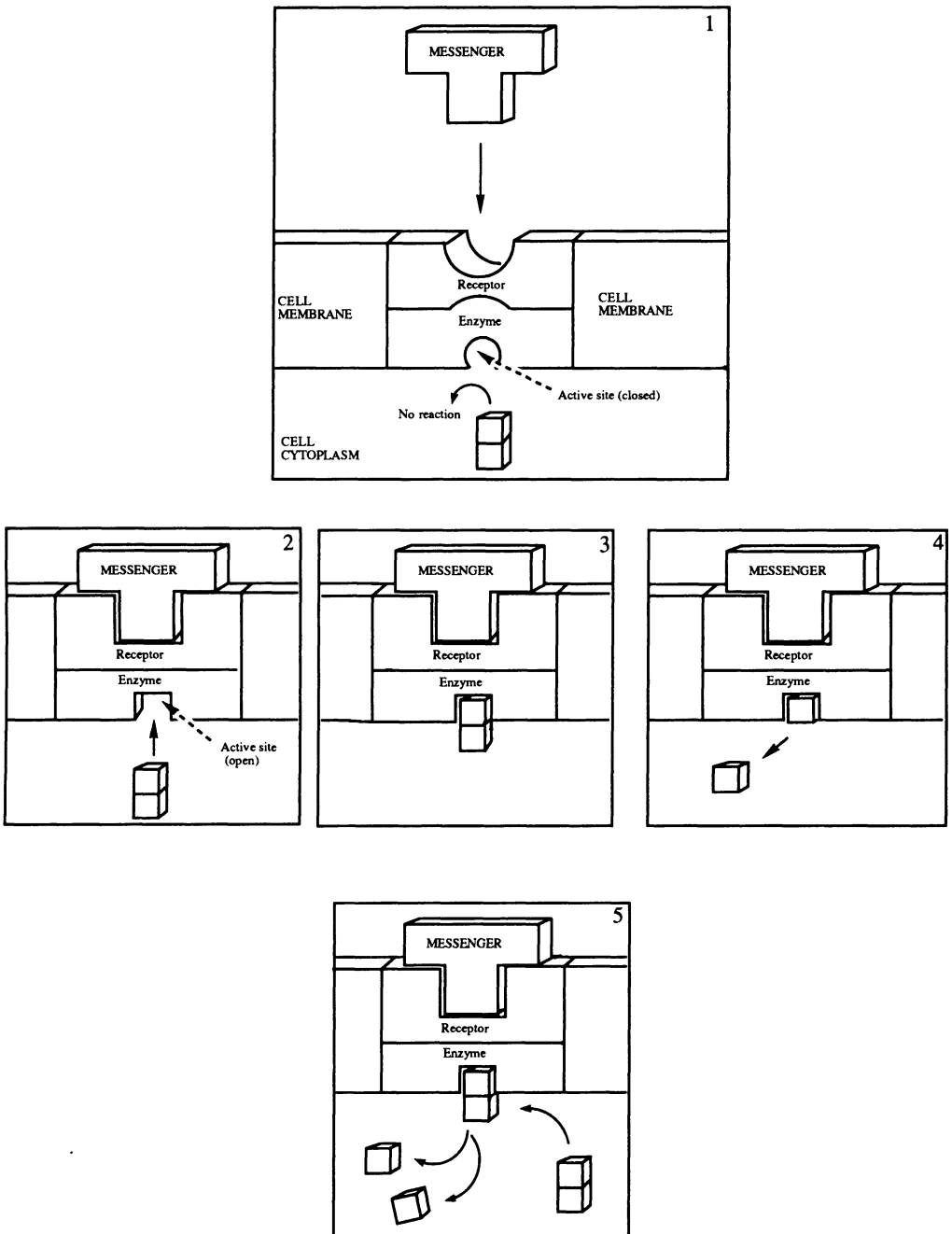

Fig. 5.9 Membrane-bound enzyme activation.

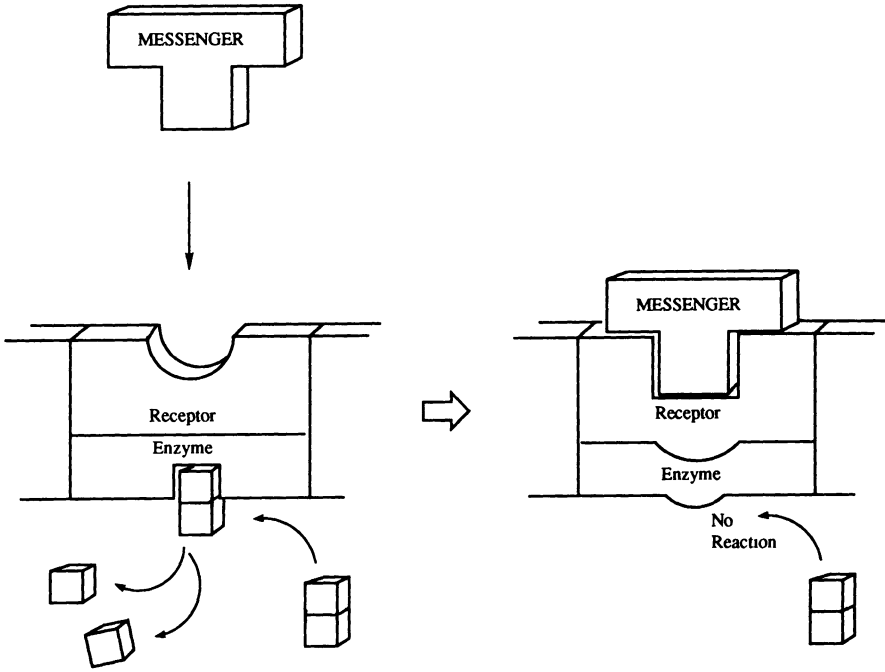

Fig. 5.10 Membrane-bound enzyme deactivation.

change in shape conceals the active site, shutting down that particular reaction (Fig. 5.10).

Neurotransmitters switch on and off membrane-bound enzymes, but to date there is no evidence that a receptor protein is directly linked to an enzyme as described above. The current theory is more complicated and is described in Appendix 3.

Regardless of the mechanism involved, the overall result is the same. A change in receptor shape (or tertiary structure) leads eventually to the activation (or deactivation) of enzymes. Since enzymes can catalyse the reaction of a large number of molecules, there is once again an amplification of the original message such that a relatively small number of neurotransmitter molecules can lead to a biological result.

To conclude, the mechanisms by which neurotransmitters pass on their message involve changes in molecular shape rather than chemical reactions. These changes in shape will ultimately lead to some sort of chemical reaction involving enzymes. This topic is covered more fully in Appendix 3.

We come now to a question which has been avoided until now.

5.5 How does a receptor change shape?

We have seen already that it is the messenger molecule which induces the receptor to change shape, but how does it do it? It is not simply, as one might think, a moulding

process whereby the receptor wraps itself around the shape of the messenger molecule. The answer lies rather in specific binding interactions between messenger and receptor. These are the same interactions already described in Chapter 4 for enzyme/substrate binding, i.e. ionic bonding, hydrogen-bonding, and van der Waals bonding. The messenger and the receptor protein both take up conformations or shapes to maximize these bonding forces. As with enzyme substrate binding, there is a fine balance involved in receptor/messenger bonding. The bonding forces must be large enough to change the shape of the receptor in the first place but not so strong that the messenger is unable to leave again. Most neurotransmitters bind quickly to their receptors, then 'shake themselves loose again' as soon as the message has been received.

As an example of the various binding forces involved, let us consider a scenario involving a hypothetical neurotransmitter and receptor as shown in Fig. 5.11. The neurotransmitter has an aromatic ring which can interact with a hydrophobic binding site by van der Waals forces, an alcoholic group which can interact by hydrogen bonding, and a charged nitrogen centre which can interact by ionic forces.

The hypothetical receptor protein is positioned in the cell membrane such that it is sealing an ion channel and contains three binding areas (Fig. 5.12).

If the binding site has complementary binding groups for the groups described above, then the drug can fit into the binding site and bind strongly. This is all very well, but now that it has docked, how does it make the receptor change shape? As before, we have to propose that the fit is not quite exact or else there would be no reason for the receptor to change shape. In this example, we can envisage our messenger molecule fitting into the binding site and binding well to two of the three possible binding sites. The third binding site, however, (the ionic one), is not quite in the right position (Fig. 5.13). It is close enough to have a weak interaction, but not close enough for the optimum interaction. The receptor protein is therefore forced to alter shape in order to get the best binding interaction. The carboxylate group is pulled closer to the positively charged nitrogen on the messenger molecule and, as a result, the lock-gate is opened and will remain open until the messenger molecule detaches from the binding site, and allows the receptor to return to its original shape.

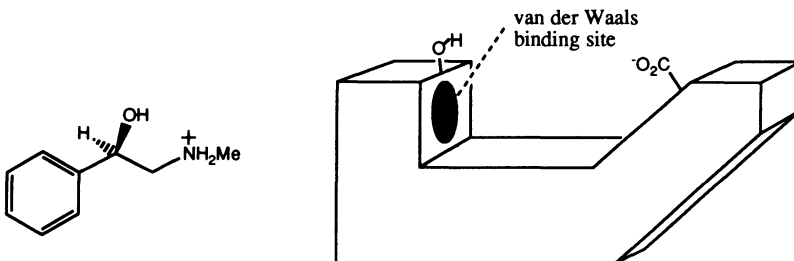

Fig. 5.11 A hypothetical neurotransmitter and receptor.

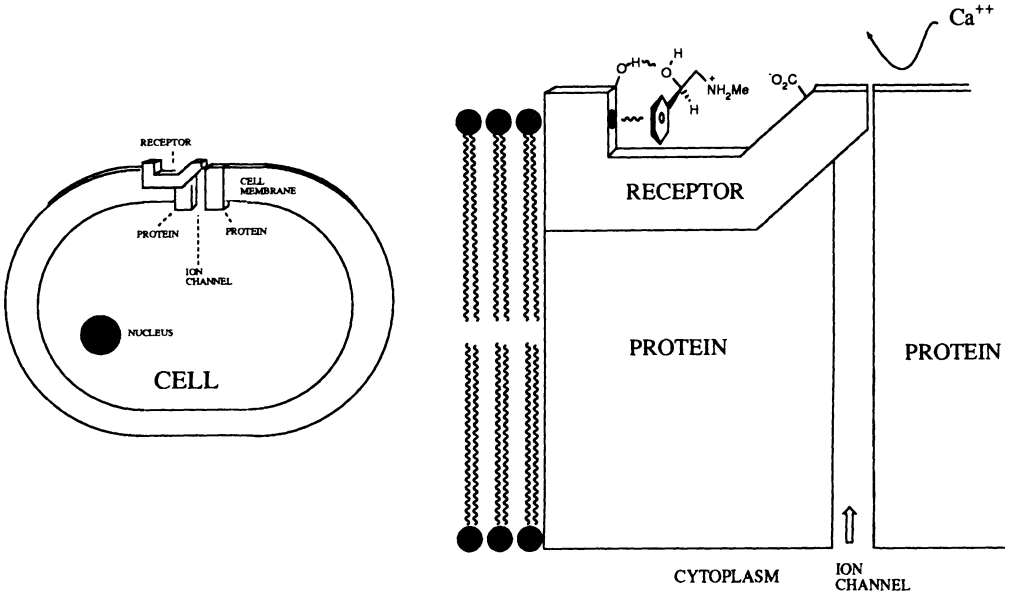

Fig. 5.12 Receptor protein positioned in the cell membrane.

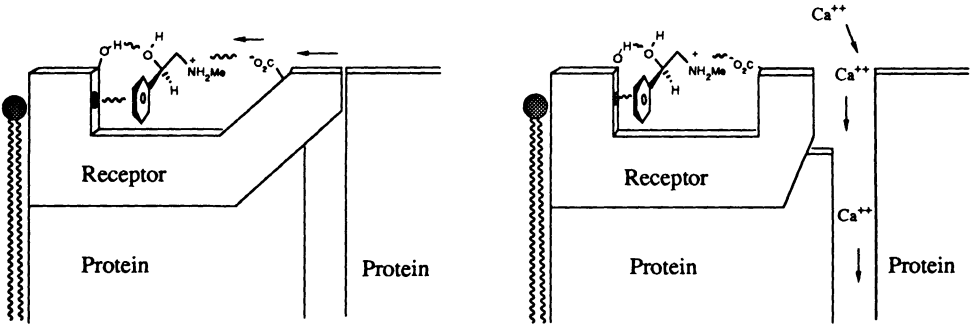

Fig. 5.13 Opening of the 'lock gate'.

5.6 The design of agonists

We are now at the stage of understanding how drugs might be designed such that they mimic the natural neurotransmitters. Assuming that we know what binding groups are present in the receptor site and where they are, we can design drug molecules to interact with the receptor. Let us look at this more closely and consider the following requirements in turn.

1. The drug must have the correct binding groups.
2. The drug must have these binding groups correctly positioned.
3. The drug must be the right size for the binding site.

5.6.1 Binding groups

If we consider our hypothetical receptor and its natural neurotransmitter, then we might reasonably predict which of a series of molecules would interact with the receptor and which would not.

For example, consider the structures in Fig. 5.14. They all look different, but they all contain the necessary binding groups to interact with the receptor. Therefore, they may well be potential agonists or alternatives for the natural neurotransmitter.

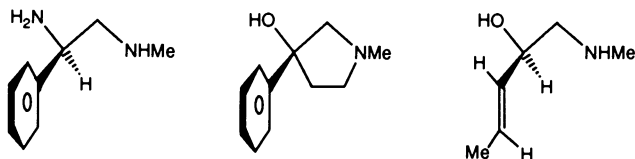

Fig. 5.14 Possible agonists.

However, the structures in Fig. 5.15 lack one or more of the required binding groups and might therefore be expected to have poor activity. We would expect them to drift into the receptor site and then drift back out again, binding only weakly if at all.

Of course, we are making an assumption here; that all three binding groups are essential. It might be argued that a compound such as structure II in Fig. 5.15 might be effective even though it lacks a suitable hydrogen bonding group. Why, for example, could it not bind initially by van der Waals forces alone and then alter the shape of the receptor protein via ionic bonding?

In fact, this seems unlikely when we consider that neurotransmitters appear to bind, pass on their message and then leave the binding site very quickly. In order to do that, there must be a fine balance in the binding forces between receptor and

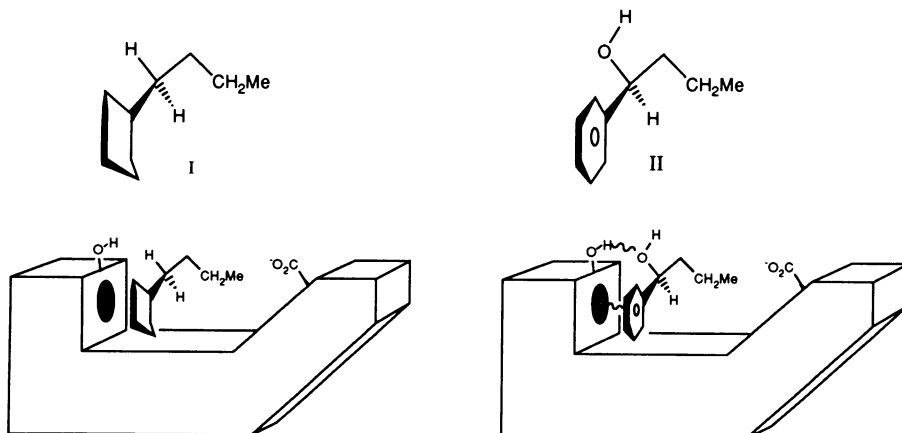

Fig. 5.15 Structures possessing fewer than the required number of binding sites.

neurotransmitter. The binding forces must be strong enough to bind the neurotransmitter effectively such that the receptor changes shape. However, the binding forces cannot be too strong, or else the neurotransmitter would not be able to leave and the receptor would not be able to return to its original shape. Therefore, it is reasonable to assume that a neurotransmitter needs all of its binding interactions to be effective. The lack of even one of these interactions would lead to a significant loss in activity.

5.6.2 Position of binding groups

The molecule may have the correct binding groups, but if they are in the wrong positions, they will not all be able to form bonds at the same time. As a result, bonding would be weak and the molecule would very quickly drift away. Result—no activity.

A molecule such as the one shown in Fig. 5.16 obviously has its binding groups in the wrong position, but there are more subtle examples of molecules which do not have the correct arrangement of binding groups. For example, the mirror image of our hypothetical neurotransmitter would not fit (Fig. 5.17). The structure has the same formula and the same constitutional structure as our original structure. It will have the same physical properties and undergo the same chemical reactions, but it is not the same shape. It is a non-superimposable mirror image and it cannot fit the receptor site (Fig. 5.18).

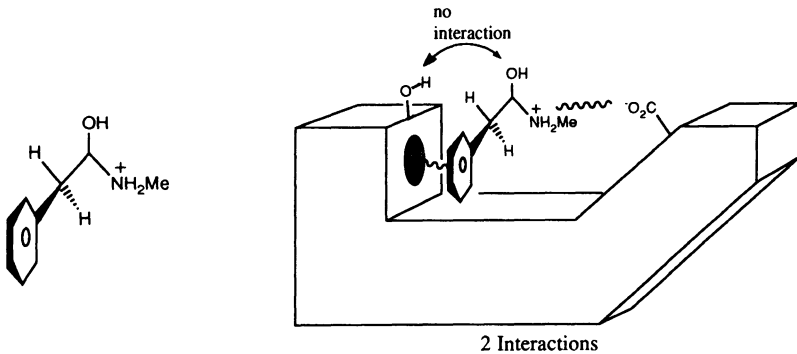

Fig. 5.16 Molecule with binding groups in incorrect positions.

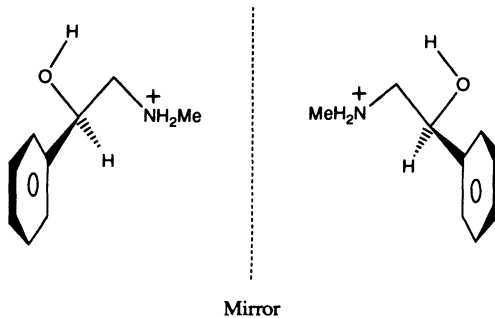

Fig. 5.17 Mirror image of hypothetical neurotransmitter.

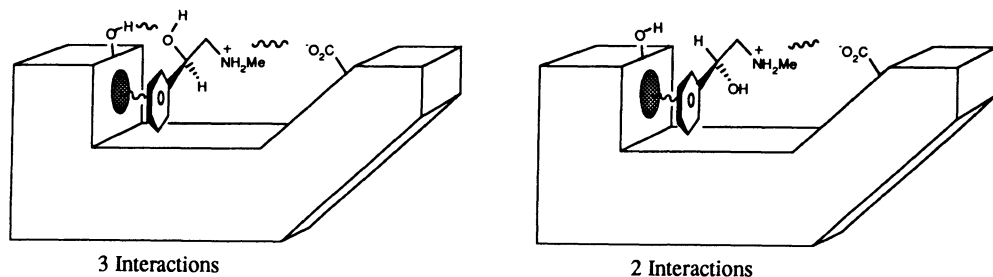

Fig. 5.18 Interactions between the hypothetical neurotransmitter and its mirror image with the receptor site.

Compounds which have non-superimposable mirror images are termed chiral or asymmetric. There are only two detectable differences between the two mirror images (or enantiomers) of a chiral compound. They rotate plane polarized light in opposite directions and they interact differently with other chiral systems such as enzymes. This has very important consequences for the pharmaceutical industry.

Pharmaceutical agents are usually synthesized from simple starting materials using simple achiral (symmetrical) chemical reagents. These reagents are incapable of distinguishing between the two mirror images of a chiral compound. As a result, most chiral drugs are synthesized as a mixture of both mirror images (a racemate). However, we have seen from our own simple example that only one of these enantiomers is going to interact with a receptor. What happens to the other enantiomer?

At best, it floats about in the body doing nothing. At worst, it interacts with a totally different receptor and results in an undesired side-effect. Herein lies the explanation for the thalidomide tragedy. One of the enantiomers was an excellent sedative. The other reacted elsewhere in the body as a poison and was teratogenic (induced abnormalities in human embryos). If the two enantiomers had been separated, then the tragedy would not have occurred.

Even if the 'wrong' enantiomer does not do any harm, it seems to be a great waste of time, money and effort to synthesize drugs which are only 50 per cent efficient. That is why one of the biggest areas of chemical research in recent years has been in the field of asymmetric synthesis—the synthesis in the laboratory of a single enantiomer of a chiral compound.

Of course, nature has been at it for millions of years. Since nature has chosen to work with only the 'left-handed' enantiomer of amino acids,² enzymes (made up of

² Naturally occurring amino acids exist as the one enantiomer, termed the L-enantiomer. This terminology is historical and defines the absolute configuration of the chiral carbon present at the 'head-group' of the amino acid. The current terminology for chiral centres is to define them as *R* or *S* according to a set of rules known as the Cahn–Ingold–Prelog rules. Naturally occurring amino acids exist as the (*S*)-configuration, but the older terminology still dominates in the case of amino acids.

Experimentally, the L-amino acids were found to rotate plane polarized light anticlockwise or to the left. Hence the expression left-handed amino acids.

left-handed amino acids) are also present as single enantiomers and therefore catalyse enantiospecific reactions—reactions which give only one enantiomer.

The importance of having binding groups in the correct position has led medicinal chemists to design drugs based on what is considered to be the important pharmacophore of the messenger molecule. In this approach, it is assumed that the correct positioning of the binding groups is what decides whether the drug will act as a messenger or not, and that the rest of the molecule serves only to hold the groups in these positions. Therefore, the activity of apparently disparate structures at a receptor can be explained if they all contain the correct binding forces at the correct positions. The design of totally novel structures or molecular frameworks to hold these binding groups in the correct positions could then be proposed, leading to a new series of drugs. There is, however, a limiting factor to this which will now be discussed.

5.6.3 Size and shape

It is possible for a compound to have the correct binding groups in the correct positions and yet fail to interact effectively if it has the wrong size or shape.

As an example, let us consider the structure shown in Fig. 5.19 as a possible candidate for our hypothetical receptor system.

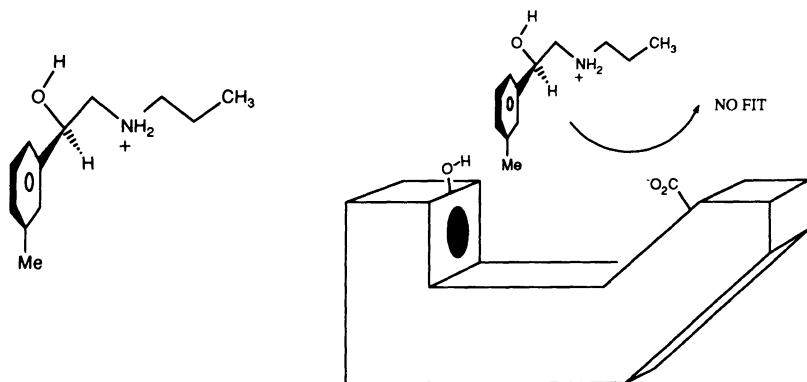

Fig. 5.19 Structure with a *para*-methyl group.

The structure has a *meta*-methyl group on the aromatic ring and a long alkyl chain containing the nitrogen atom. By considering size factors alone, we could conclude that both these features would prevent this molecule from binding effectively to the receptor.

The *meta*-methyl group would act as a buffer and prevent the structure from 'sinking' deep enough into the binding site for effective binding. Furthermore, the long alkyl chain on the nitrogen atom would make that part of the molecule too long for the space available to it.

A thorough understanding of the space available in the binding site is therefore necessary when designing analogues which will fit it.

5.7 The design of antagonists

5.7.1 Antagonists acting at the binding site

We have seen how it might be possible to design drugs to mimic the natural neurotransmitters (agonists) and how these would be useful in treating a shortage of the natural neurotransmitter. However, suppose that we have too much neurotransmitter operating in the body. How could a drug counteract that?

There are several strategies, but in theory we could design a drug (an antagonist) which would be the right shape to bind to the receptor site, but which would either fail to change the shape of the receptor protein or would distort it too much. Consider the following scenario.

The compound shown in Fig. 5.20 fits the binding site perfectly and as a result does not cause any change of shape. Therefore, there is no biological effect and the binding site is blocked to the natural neurotransmitter.

In such a situation, the antagonist has to compete with the agonist for the receptor, but usually the antagonist will get the better of this contest since it often binds more strongly.

To sum up, if we know the shape and make-up of receptor binding sites, then we should be able to design drugs to act as agonists or antagonists. Unfortunately, it is not as straightforward as it sounds. Finding the receptor and determining the layout of its binding site is no easy task. In reality, the theoretical shape of many receptor sites have been worked out by synthesizing a large number of compounds and considering those molecules which fit and those which do not—a bit like a 3D jigsaw.

However, the recent advent of computer-based molecular graphics and the availability of X-ray crystallographic data now allow a more accurate representation of proteins and their binding sites (Chapter 7) and promise to spark off a new phase of drug development.

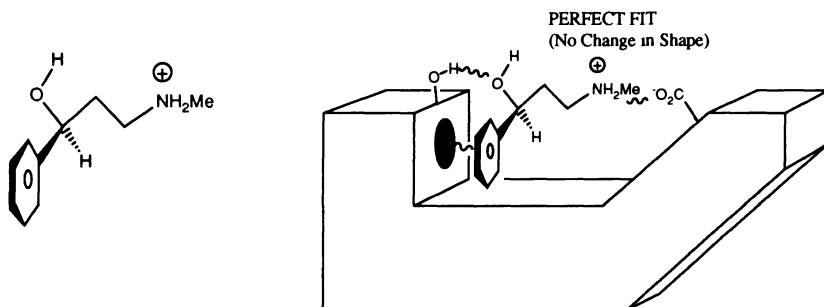

Fig. 5.20 Compound acting as an antagonist at the binding site.

5.7.2 Antagonists acting outwith the binding site

Even if the 'layout' of a binding site is known, it may not help in the design of antagonists. There are many example of antagonists which bear no apparent structural similarity to the native neurotransmitter and could not possibly fit the geometrical requirements of the binding site. Such antagonists frequently contain one or more aromatic rings, suggesting van der Waals interactions are important in their binding, yet there may not be any corresponding area in the binding site. How then do such antagonists work? There are two possible explanations.

Allosteric antagonists

The antagonist may bind to a totally different part of the receptor. The process of binding could alter the shape of the receptor protein such that the neurotransmitter binding site is distorted and is unable to recognize the natural neurotransmitter (Fig. 5.21). Therefore, binding between neurotransmitter and receptor would be prevented and the message lost. This form of antagonism is a non-competitive form of antagonism since the antagonist is not competing with the neurotransmitter for the same binding site (compare allosteric inhibitors of enzymes—Chapter 4).

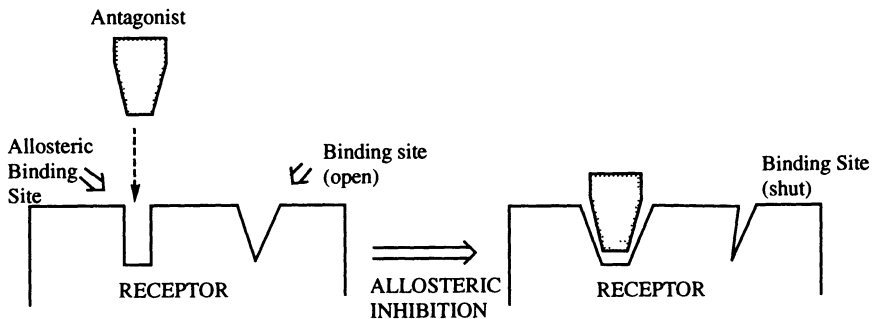

Fig. 5.21 Allosteric antagonists.

Antagonism by the 'umbrella' effect

It has to be remembered that the receptor protein is bristling with amino acid residues, all of which are capable of interacting with a visiting molecule. Therefore, it is unrealistic to think of the neurotransmitter binding site as an isolated 'landing pad', surrounded by a bland, featureless 'no go zone'. There will almost certainly be areas close to the binding site which are capable of binding through van der Waals, ionic, or hydrogen bonding forces.

These areas may not be used by the natural neurotransmitter, but they can be used by other molecules. If these molecules bind to such areas and happen to lie over or partially lie over the neurotransmitter binding site, then they will act as antagonists

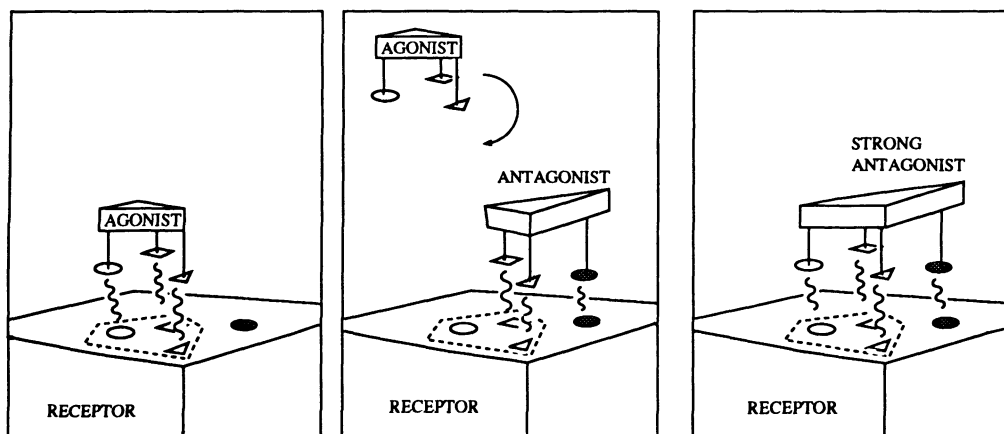

Fig. 5.22 Antagonism by the 'umbrella effect'.

and prevent the neurotransmitter reaching its binding site (Fig. 5.22). This form of antagonism has also been dubbed the 'umbrella effect' and is a form of competitive antagonism since the normal binding site is directly affected.

Many antagonists are capable of binding to both the normal binding site and the neighbouring sites. Such antagonists will clearly bind far more strongly than agonists. Because of this stronger binding, antagonists have been useful in the isolation and identification of specific receptors present in tissues. A further tactic in this respect is to incorporate a highly reactive chemical group—usually an electrophilic group—into such a powerful antagonist. The electrophilic group will then react with any convenient nucleophilic group on the receptor surface and alkylate it to form a strong covalent bond. The antagonist will then be irreversibly tied to the receptor and can act as a molecular label. One example is tritium-labelled propylbenzylcholine mustard—used to label the muscarinic acetylcholine receptor (Fig. 5.23) (see also Chapter 10).

5.8 Partial agonists

Frequently drugs are discovered which cannot be defined as pure antagonists or pure agonists.

Such compounds bind to the receptor site and block access to the natural neurotransmitter, and so in this sense they are antagonists. However, they also activate the receptor very weakly such that a slight signal is received. In our hypothetical situation (Fig. 5.24), we could imagine a partial agonist being a molecule which is almost a perfect fit for the binding site, such that binding results in only a very slight distortion of the receptor. This would then only partly open the ion channel.

An alternative explanation for partial agonism is that the molecule in question

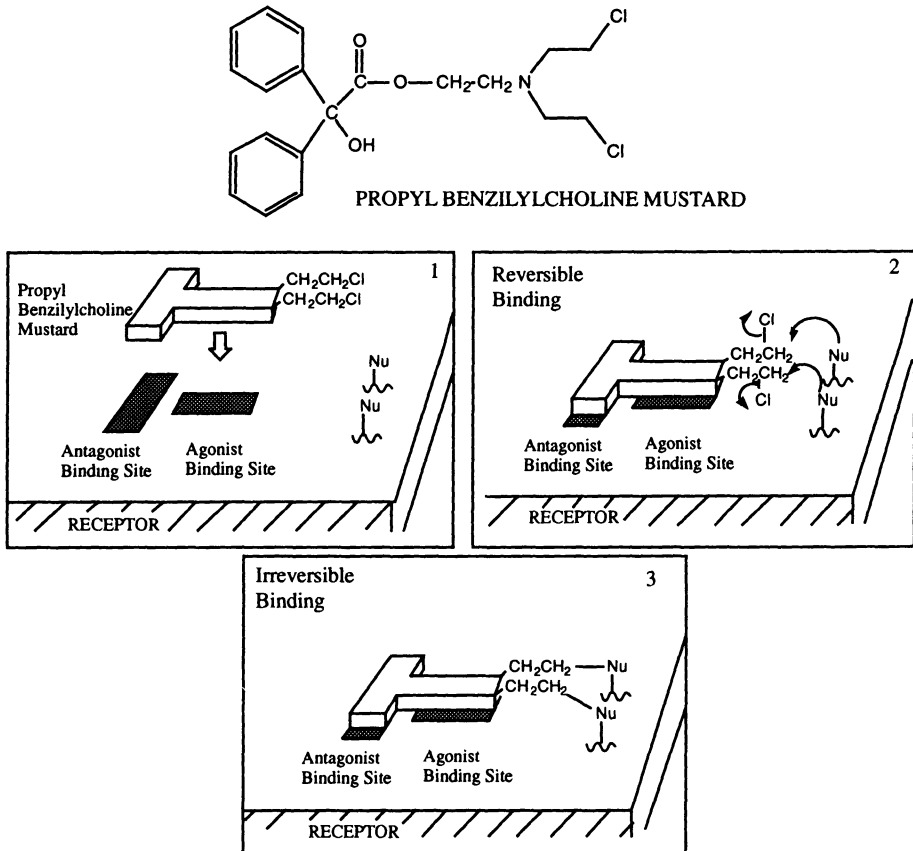

Fig. 5.23 Antagonist used as a molecular label.

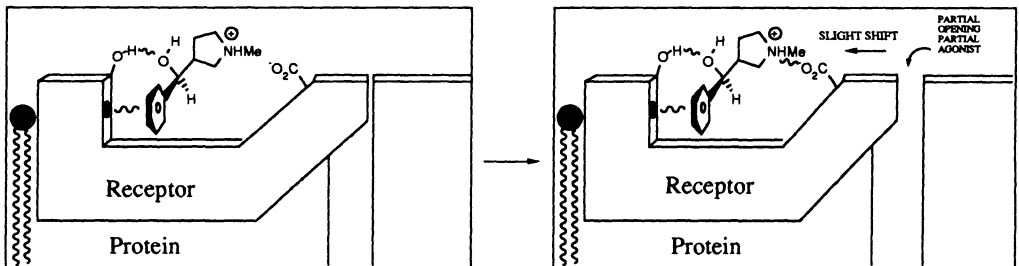

Fig. 5.24 Partial agonism.

might be capable of binding to a receptor in two different ways by using different binding groups. One method of binding would activate the receptor, while the other would not. The balance of agonism versus antagonism would then depend on the relative proportions of molecules binding by either method. Examples of partial agonists are discussed in Chapters 11 and 12.

5.9 Desensitization

Some drugs bind relatively strongly to a receptor, switch it on, but then subsequently block the receptor. Thus, they are acting as agonists, then antagonists. The mechanism of how this takes place is not clear. One theory is that receptors can only remain activated for a certain period of time. Once that period is up, another change in the tertiary structure takes place which switches the receptor off, despite the binding site being occupied (Fig. 5.25). This altered tertiary structure is then maintained as long as the binding site is occupied. When the drug eventually leaves, the receptor returns to its original resting shape.

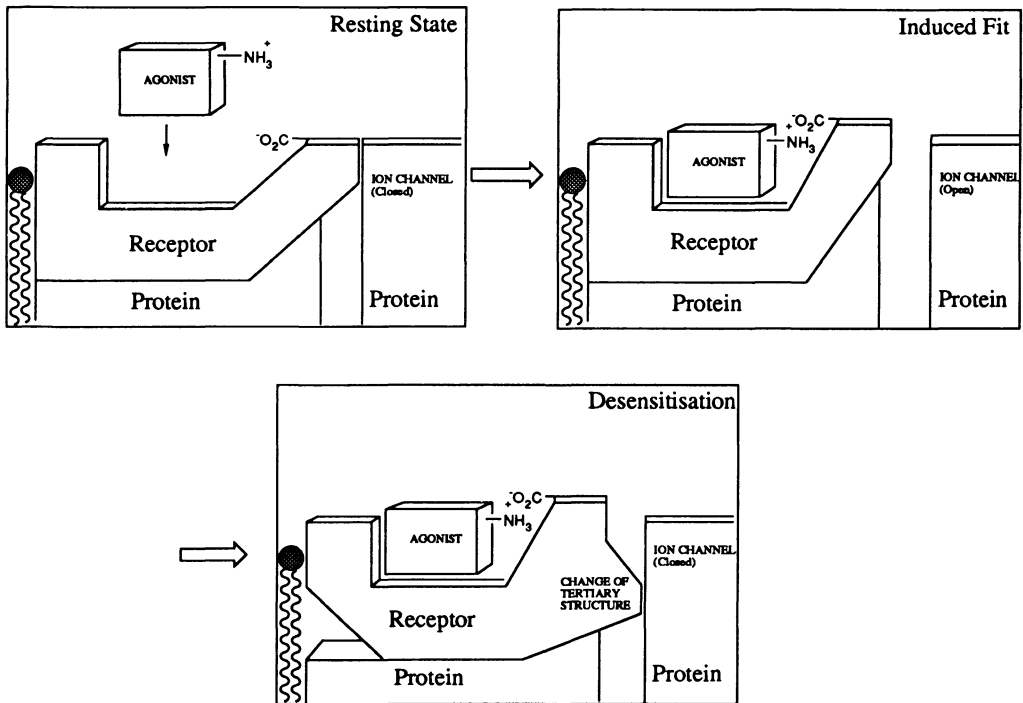

Fig. 5.25 Desensitization.

In conclusion, it is thought that the best agonists bind swiftly to the receptor, pass on their message and then leave quickly. Antagonists, in contrast, tend to be slow to add and slow to leave.

5.10 Tolerance and dependence

It has been discovered that 'starving' a target cell of a certain neurotransmitter induces that cell to synthesize more receptors. By doing so, the cell gains a greater sensitivity

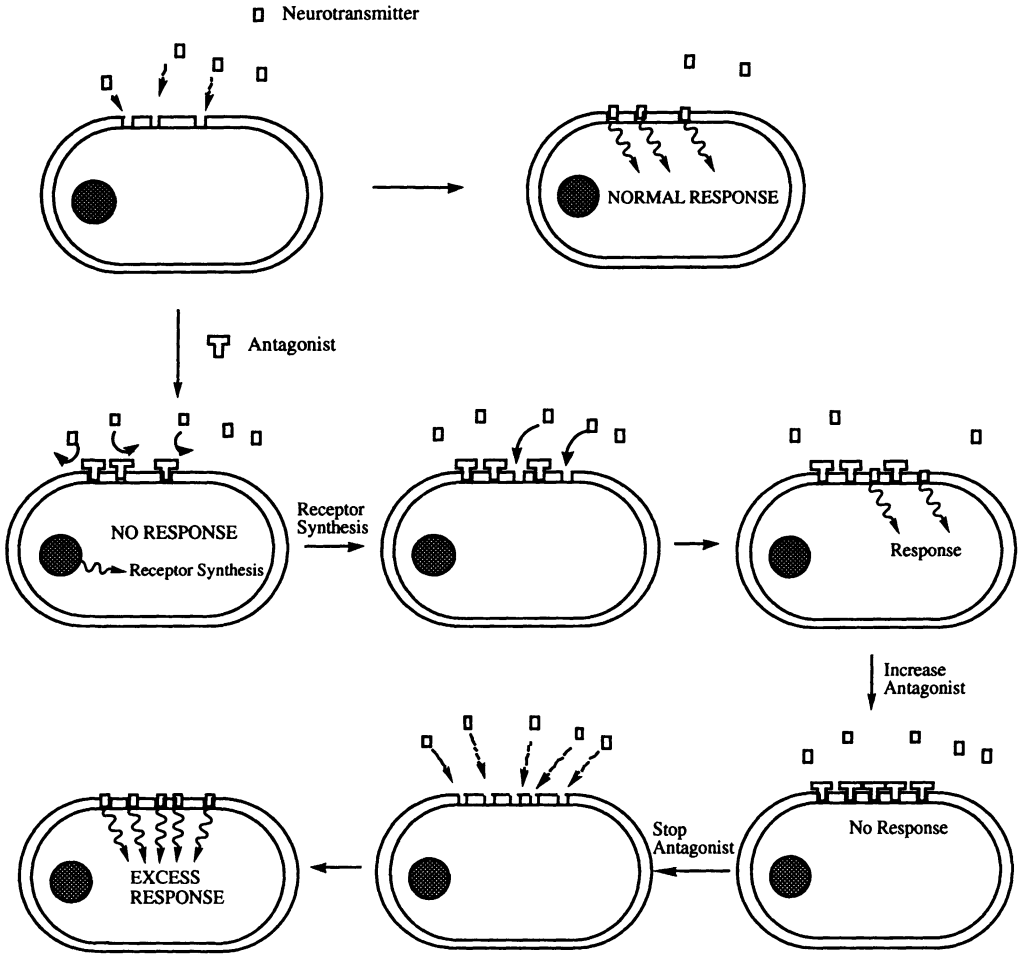

Fig. 5.26 Process of increasing cell sensitivity.

for what little neurotransmitter is available. This process can explain the phenomena of tolerance and dependence (Fig. 5.26).

Tolerance is a situation where higher levels of a drug are required to get the same biological response. If a drug is acting to suppress the binding of a neurotransmitter, then the cell may respond by increasing the number of receptors. This would require increasing the dose to regain the same level of antagonism.

If the drug was suddenly stopped, then all the receptors would suddenly become available. There would now be an excess of receptors which would make the cell supersensitive to normal levels of neurotransmitter. This would be equivalent to receiving a drug overdose. The resulting biological effects would explain the distressing withdrawal symptoms resulting from stopping certain drugs. These withdrawal symptoms would continue until the number of receptors returned to their original

level. During this period, the patient may be tempted to take the drug again in order to 'return to normal' and will have then gained a dependence on the drug.

The problem of tolerance is also discussed in Appendix 3.

It is only in recent years that medicinal chemists have begun to understand receptors and drug receptor interactions. This increased understanding should revolutionize the subject in the years to come.

6 ■ Nucleic acids

Although the majority of drugs act on protein structures, there are several examples of important drugs which act directly on nucleic acids to disrupt replication, transcription, and translation.

There are two types of nucleic acid—DNA (deoxyribonucleic acid) and RNA (ribonucleic acid). We shall first consider the structure of DNA and the drugs which act on it.

6.1 Structure of DNA

As with proteins, DNA has a primary, secondary, and tertiary structure.

6.1.1 The primary structure of DNA

The primary structure of DNA is the way in which the DNA building blocks are linked together. Whereas proteins have over twenty building blocks to choose from, DNA has only four—the nucleosides deoxyadenosine, deoxyguanosine, deoxycytidine, and deoxythymidine (Fig. 6.1).

Each nucleoside is constructed from two components—a deoxyribose sugar and a base. The sugar is the same in all four nucleosides and only the base is different. The four possible bases are two bicyclic purines (adenine and guanine), and two smaller pyrimidine structures (cytosine and thymine) (Fig. 6.2).

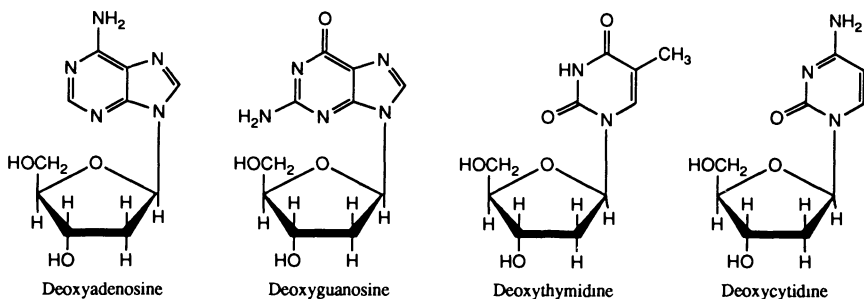

Fig. 6.1 The building blocks of DNA—nucleosides.

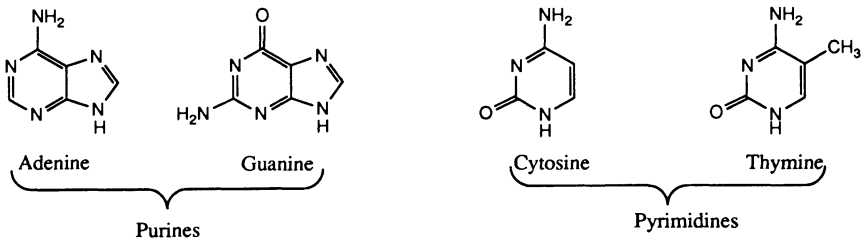

Fig. 6.2 The four bases of nucleosides.

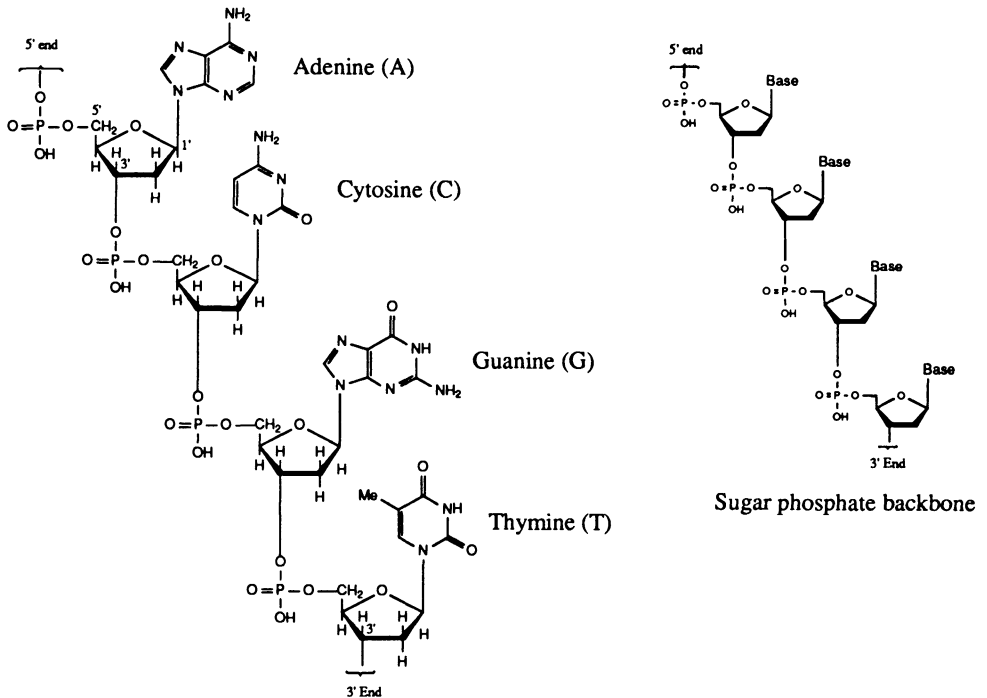

Fig. 6.3 Linkage of nucleosides through phosphate groups.

The nucleoside building blocks are joined together through phosphate groups which link the 5'-hydroxyl group of one nucleoside unit to the 3'-hydroxyl group of the next (Fig. 6.3).

With only four types of building block available, the primary structure of DNA is far less varied than the primary structure of proteins. As a result, it was long thought that DNA only had a minor role to play in cell biochemistry, since it was hard to see how such an apparently simple molecule could have anything to do with the mysteries of the genetic code.

The solution to this mystery lies in the secondary structure of DNA.

6.1.2 The secondary structure of DNA

Watson and Crick solved the secondary structure of DNA by building a model that fitted all the known experimental results.

The structure consists of two DNA chains arranged together in a double helix of constant diameter (Fig. 6.4). The double helix can be seen to have a major groove and a minor groove which are of some importance to the action of several antibacterial agents (see later).

The structure relies crucially on the pairing up of nucleic acid bases between the two chains. Adenine pairs only with thymine via two hydrogen bonds, whereas guanine pairs only with cytosine via three hydrogen bonds. Thus, a bicyclic purine base is always linked with a smaller monocyclic pyrimidine base to allow the constant diameter of the double helix. The double helix is further stabilized by the fact that the base pairs are stacked one on top of each other, allowing hydrophobic interactions

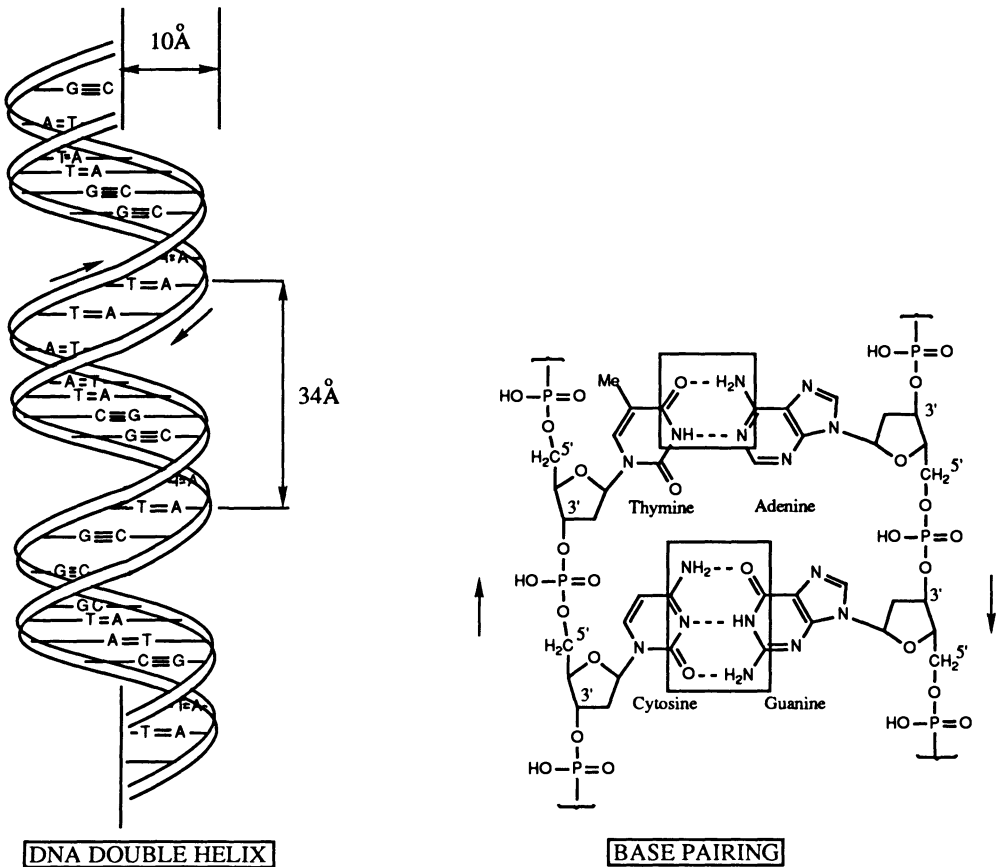

Fig. 6.4 The secondary structure of DNA.

between the heterocyclic rings. The polar sugar phosphate backbone is placed to the outside of the structure and therefore can form favourable polar interactions with water.

The fact that adenine always binds to thymine, and cytosine always binds to guanine means that the chains are complementary to each other. In other words, one chain can be visualized as a negative image of its partner. It is now possible to see how replication (the copying of the genetic information) is feasible. If the double helix unravels, then a new chain can be constructed on each of the original chains (Fig. 6.5). In other words, each of the original chains can act as a template for the construction of a new and identical double helix.

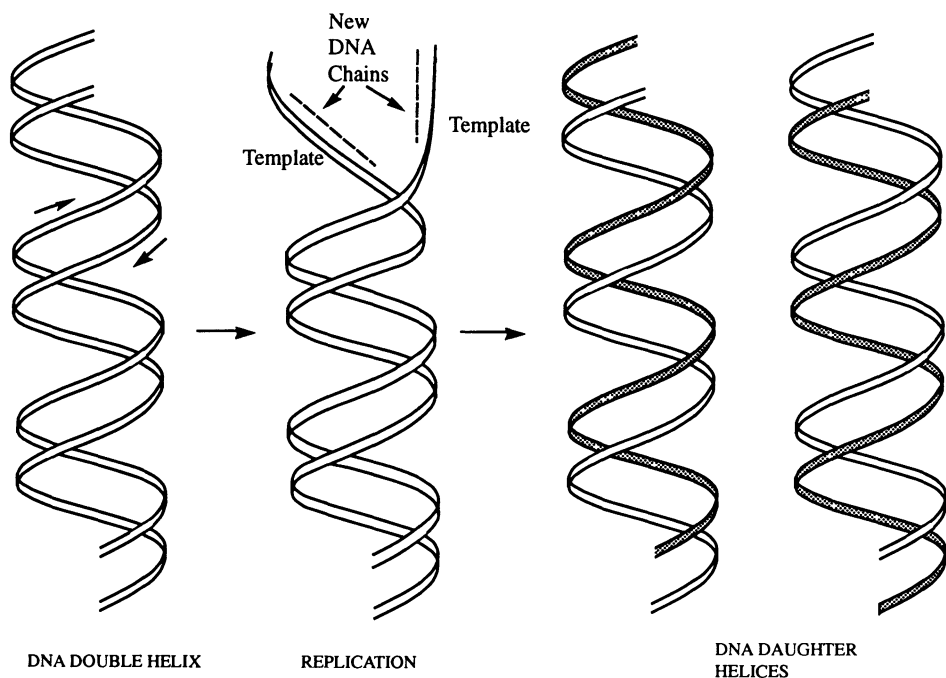

Fig. 6.5 Replication of DNA chains.

It is less obvious how DNA can code for proteins. How can four nucleotides code for over twenty amino acids?

The answer lies in the triplet code. In other words, an amino acid is not coded by one nucleotide but by a set of three. There are sixty-four ways in which four nucleotides can be arranged in sets of three—more than enough for the task required.

6.1.3 The tertiary structure of DNA

The tertiary structure of DNA is often neglected or ignored, but it is important to the action of the quinolone group of antibacterial agents (Chapter 10). The double helix is

able to coil into a 3D shape and this is known as supercoiling. During replication, the double strand of DNA must unravel, but due to the tertiary supercoiling this leads to a high level of strain which has to be relieved by the temporary cutting, then repair, of the DNA chain. These procedures are enzyme-catalysed and these are the enzymes which are inhibited by the quinolone antibacterial agents.

6.2 Drugs acting on DNA

In general, we can classify the drugs which act on DNA into three groups:

- (1) intercalating cytostatic agents
- (2) alkylating agents
- (3) chain 'cutters'

6.2.1 Intercalating agents

Intercalating drugs are compounds which are capable of slipping between the layers of nucleic acid base pairs and disrupting the shape of the double helix. This disruption prevents replication and transcription. One example is the antibacterial agent proflavine (Fig. 6.6).

Drugs which work in this way must be flat in order to fit between the base pairs, and must therefore be aromatic or heteroaromatic in nature. Some drugs prefer to approach the helix via the major groove, whereas others prefer access via the minor groove.

Several antibiotics such as the antitumour agents actinomycin D and adriamycin (Fig. 6.7) operate by intercalating DNA.

Actinomycin D contains two cyclic pentapeptides, but the important feature is the flat, tricyclic, heteroaromatic structure which is able to slide into the double helix. It

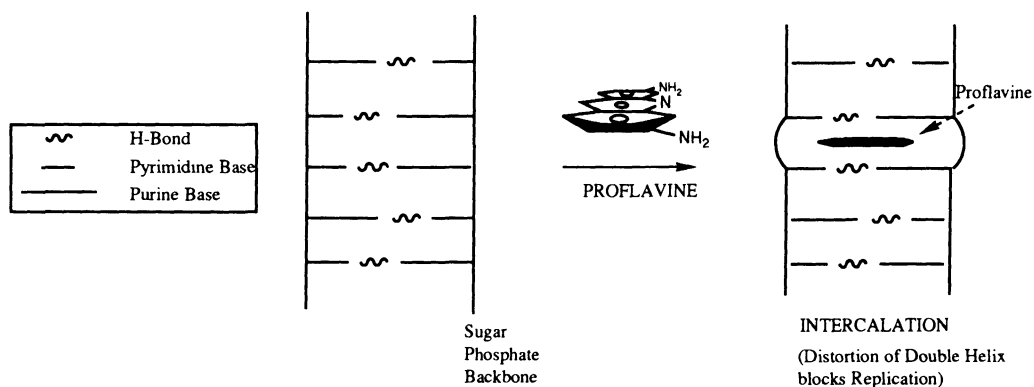

Fig. 6.6 Action of intercalating drugs.

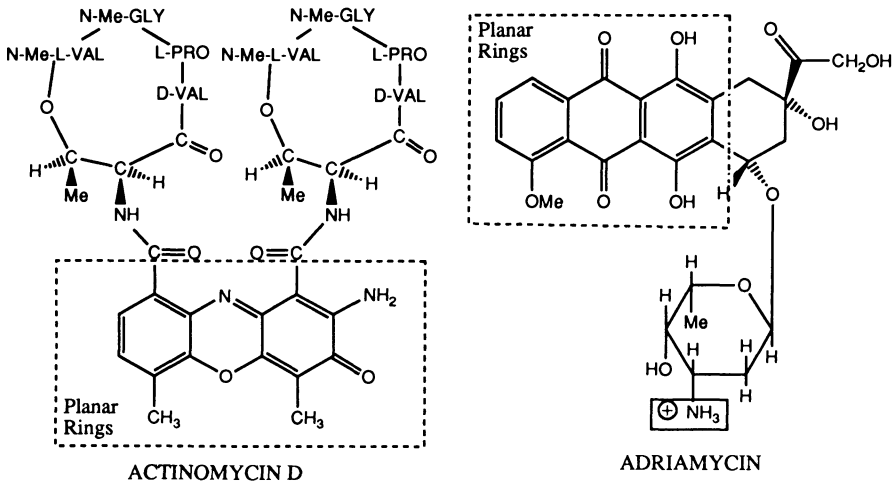

Fig. 6.7 Antibiotics which operate by intercalating DNA.

appears to favour interactions with guanine–cytosine base pairs and, in particular, between two adjacent guanine bases on alternate strands of the helix. Actinomycin D is further held in position by hydrogen bond interactions between the nucleic acid bases of DNA and the cyclic pentapeptides positioned on the outside of the helix.

Adriamycin has a tetracyclic system where three of the rings are planar and are able to fit into the double helix. The drug approaches DNA via the major groove of the double helix. The amino group attached to the sugar is important in helping to lock the antibiotic into place since it can ionize and form an ionic bond with the negatively charged phosphate groups on the DNA backbone.

The highly effective antimalarial agent chloroquine—a drug developed from quinine—can attack the malarial parasite by blocking DNA transcription as part of its action. Once again a flat heteroaromatic structure is present which can intercalate DNA (Fig. 6.8).

Aminoacridine agents such as proflavine (Fig. 6.9) are topical antibacterial agents which were used particularly in the Second World War to treat surface wounds. The

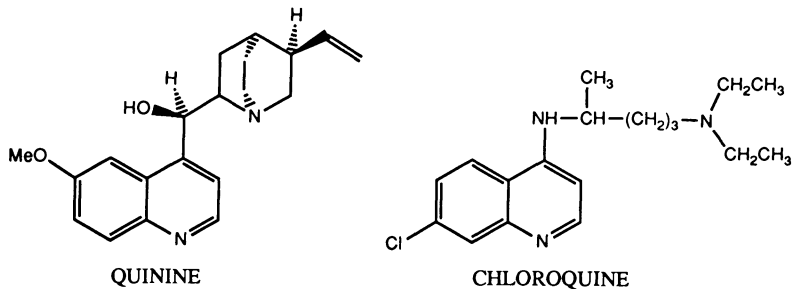

Fig. 6.8 Intercalating antimalarial drugs.

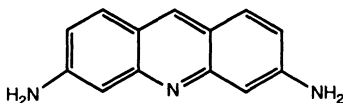

Fig. 6.9 Proflavine.

best agents are completely ionized at pH 7 and they interact with DNA in the same way as adriamycin. The flat tricyclic ring intercalates between the DNA base pairs and interacts by van der Waals forces, while the amino cations form ionic bonds with the negatively charged phosphate groups on the sugar phosphate backbone.

6.2.2 Alkylating agents

Alkylating agents are highly electrophilic compounds which will react with nucleophiles to form strong covalent bonds. There are several nucleophilic groups in DNA and in particular the 7-nitrogen of guanine. Drugs with two such alkylating groups could therefore react with a guanine on each chain and cross-link the strands such that they cannot unravel during replication or transcription.

Alternatively, the drug could link two guanine groups on the same chain such that the drug is attached like a limpet to the side of the DNA helix. Such an attachment would mask that portion of DNA and block access to the necessary enzymes required for DNA function.

Miscoding due to alkylated guanine units is also possible. The guanine base usually exists as the keto tautomer and base pairs with cytosine. Once alkylated however, guanine prefers the enol tautomer and is more likely to base pair with thymine. Such miscoding ultimately leads to an alteration in the amino acid sequence of proteins and enzymes which in turn leads to disruption of protein structure and function.

Since alkylating agents are very reactive, they will react with any good nucleophile and so they are not very selective in their action. They will alkylate proteins and other macromolecules as well as DNA. Nevertheless, alkylating drugs have been useful in the treatment of cancer. Tumour cells often divide more rapidly than normal cells and so disruption of DNA function will affect these cells more drastically than normal cells.

The nitrogen mustard compound mechlorethamine (Fig 6.10) was the first alkylating agent to be used (1942). The nitrogen atom is able to displace a chloride ion intramolecularly to form the highly electrophilic aziridine ion. Alkylation of DNA can then take place. Since the process can be repeated, cross-linking between chains will occur.

The side-reactions mentioned above can be reduced by reducing the reactivity of the alkylating agent. For example, putting an aromatic ring on the nitrogen atom instead of a methyl group (Fig. 6.11) has such an effect. The lone pair of the nitrogen is 'pulled into' the ring and is less available to displace the chloride ion. As a result,

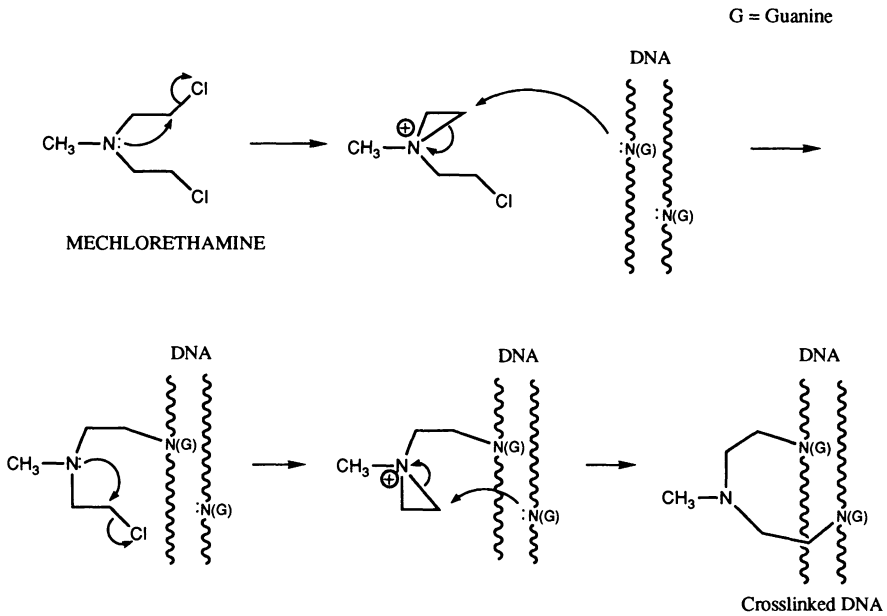

Fig. 6.10 Alkylation of DNA by the nitrogen mustard compound, mechlorethamine.

the intermediate aziridine ion is less easily formed and only strong nucleophiles such as guanine will now react with it.

Another approach which has been used to direct these alkylating agents more specifically to DNA has been to attach a nucleic acid building block onto the molecule. For example, uracil mustard (Fig. 6.12) contains one of the nucleic acid bases. This drug has been used successfully in the treatment of chronic lymphatic leukaemia and has a certain amount of selectivity for tumour cells over normal cells. This is because tumour cells generally divide faster than normal cells. As a result, nucleic acid synthesis is faster and tumour cells are 'hungrier' for the nucleic acid building blocks. The tumour cells therefore take more than their share of the building blocks and of any cytotoxic drug which mimics the building blocks. Unfortunately, this approach has not so far succeeded in achieving the high levels of selectivity desired for effective eradication of tumour cells.

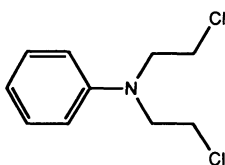

Fig. 6.11 Method of reducing reactivity of the alkylating agent.

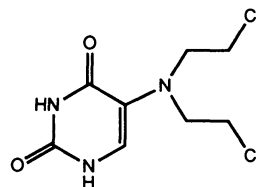
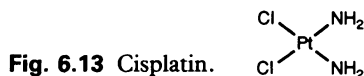

Fig. 6.12 Uracil mustard.



Cisplatin (Fig. 6.13) is a very useful antitumour agent for the treatment of testicular and ovarian tumours. Its discovery was fortuitous in the extreme, arising from research carried out to investigate the effects of an electric current on bacterial growth. During these experiments, it was discovered that bacterial cell division was inhibited. Further research led to the discovery that an electrolysis product from the platinum electrodes was responsible for the inhibition and the agent was eventually identified as *cis*-diamino platinum dichloride, known as cisplatin.

Cisplatin binds strongly to DNA in regions containing several guanidine units, binding in such a way as to form links within strands (intrastrand binding) rather than between them. Unwinding of the DNA helix takes place and transcription is inhibited.

6.2.3 Drugs acting by chain 'cutting'

Bleomycin (Fig. 6.14) is a large glycoprotein which appears to be able to cut the strands of DNA and then prevent the enzyme DNA ligase from repairing the damage. It appears to act by abstracting hydrogen atoms from DNA. The resultant radicals

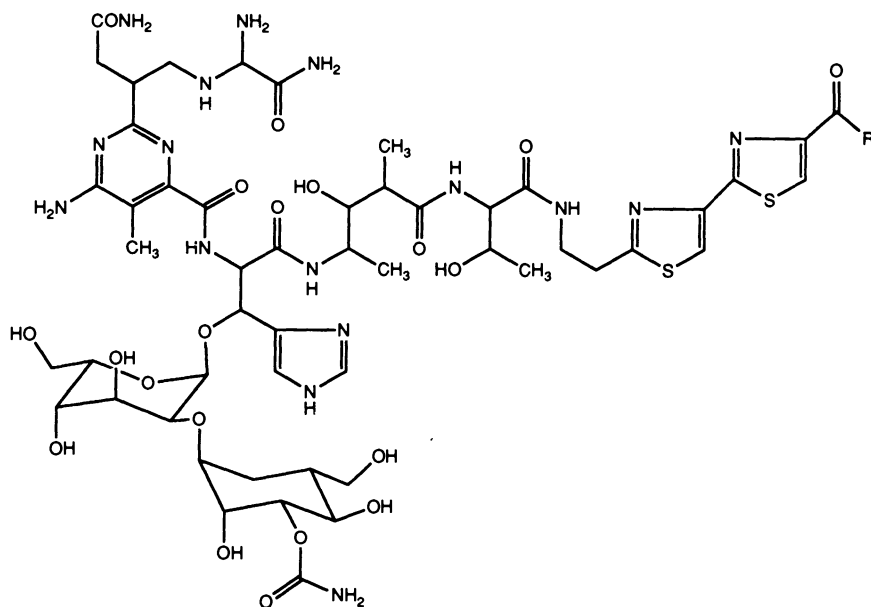

BLEOMYCIN A₂ R = NHCH₂CH₂CH₂SM₂
 BLEOMYCIN B₂ R = NHCH₂CH₂CH₂CH₂NHC(NH₂)=NH

Fig. 6.14 Bleomycin.

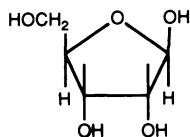

Fig. 6.15 Ribose.

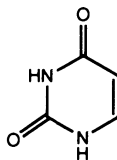

Fig. 6.16 Uracil.

react with oxygen to form peroxy species which then fragment. The drug is useful against certain types of skin cancer.

6.3 Ribonucleic acid

The primary structure of RNA is the same as DNA, with two exceptions. Ribose (Fig. 6.15) is the sugar component rather than deoxyribose, while uracil (Fig. 6.16) replaces thymine as one of the bases.

Base pairing between nucleic acid bases can occur in RNA with adenine pairing with uracil, and cytosine pairing with guanine. However, the pairing is between bases within the same chain, and it does not occur for the whole length of the molecule (e.g. Fig. 6.18). Therefore, RNA is not a double helix, but it does have regions of helical secondary structure.

Since the secondary structure is not uniform along the length of the RNA chain, more variety is allowed in RNA tertiary structure. Three types of RNA molecules have been identified with different cell functions. The three are messenger RNA (mRNA), transfer RNA (tRNA), and ribosomal RNA (rRNA).

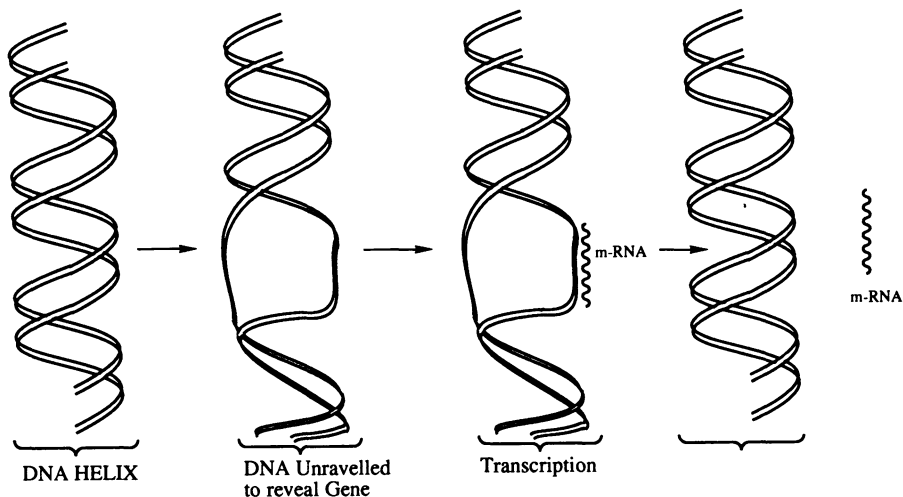

Fig. 6.17 Formation of m-RNA.

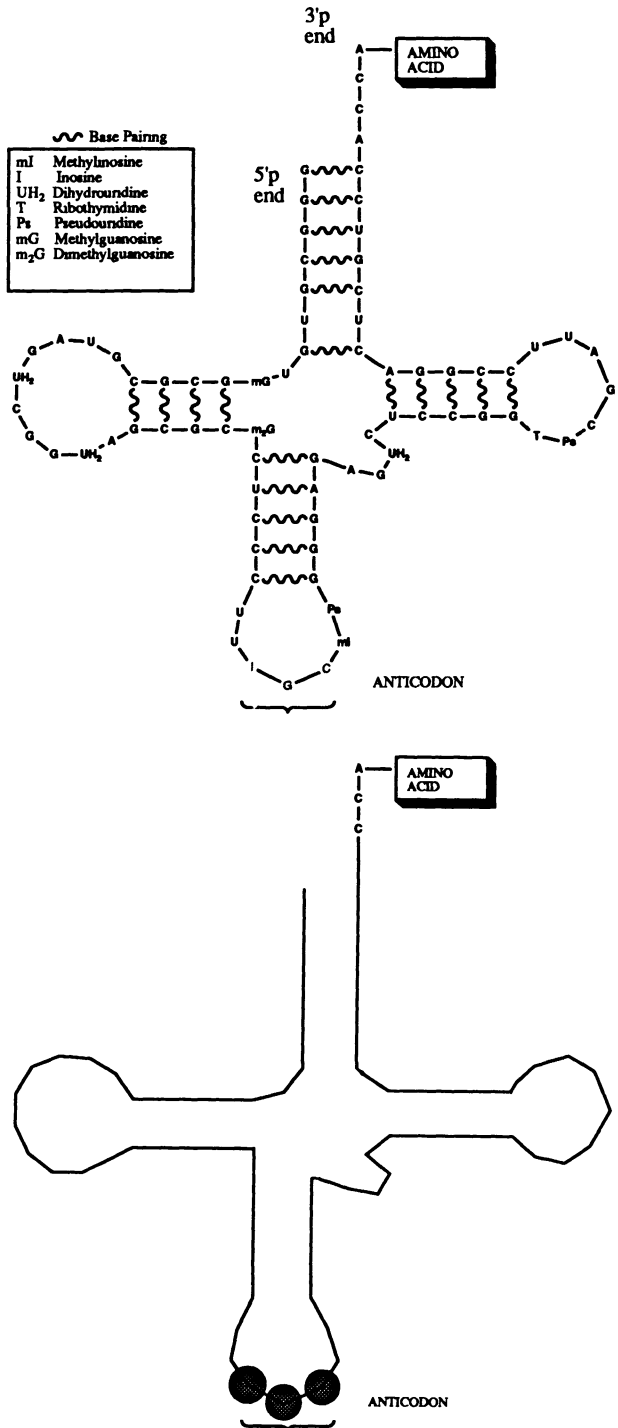

Fig. 6.18 Yeast alanine tRNA.

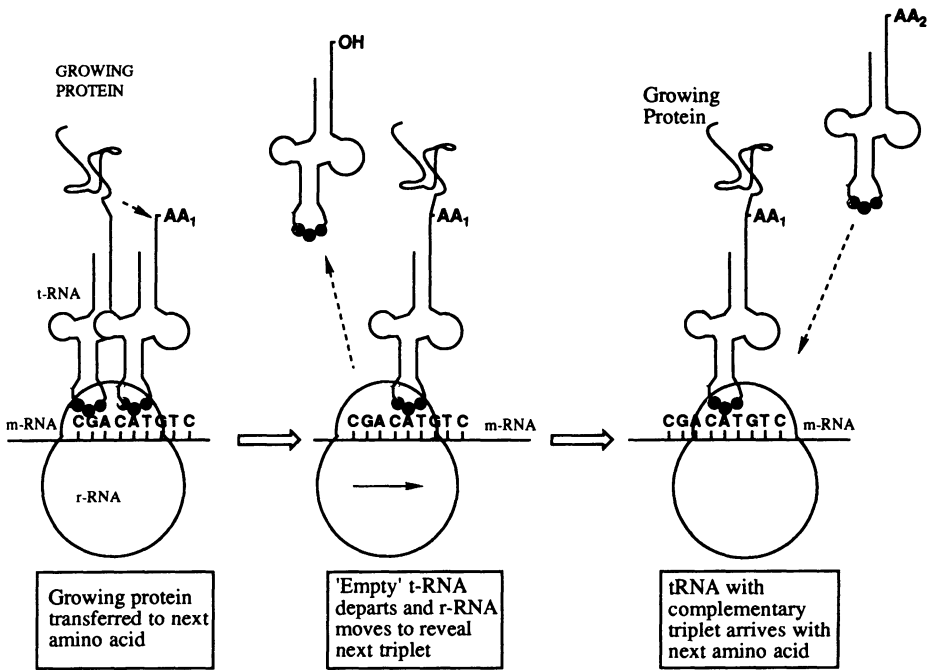

Fig. 6.19 Protein synthesis.

Messenger RNA is responsible for relaying the code for one particular protein from the DNA genetic bank to the protein 'production site'. The segment of DNA required is copied by a process called transcription. The DNA double helix unravels and the stretch which is exposed acts as a template on which the mRNA can be built (Fig. 6.17). Once complete, the mRNA leaves to seek out rRNA, while the DNA reforms the double helix.

Ribosomal RNA can be looked upon as the production site for protein synthesis. It binds to one end of the mRNA molecule, then travels along it to the other end, reading the code and constructing the protein molecule one amino acid at a time as it moves along (Fig. 6.19). There are two segments to the rRNA known as the 50S and 30S subunits.

Transfer RNA is the crucial adaptor unit which links the triplet code on mRNA to a specific amino acid. Therefore, there has to be a different tRNA for each amino acid. All the tRNAs are clover-leaf in shape with two different binding sites at opposite ends of the molecule (Fig. 6.18). One binding site is for a specific amino acid where the amino acid is covalently linked to the terminal adenosyl residue. The other is a set of three nucleic acid bases (anticodon) which will base pair with a complementary triplet on the mRNA molecule.

As rRNA travels along mRNA it reveals the triplet codes on mRNA (Fig. 6.19). As

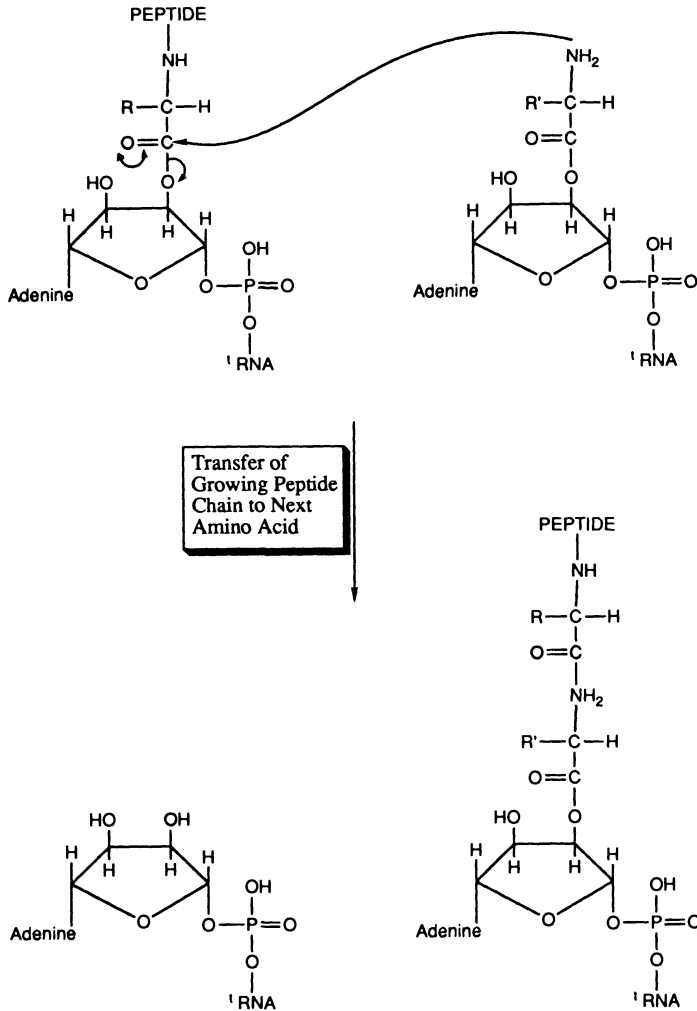

Fig. 6.20 Mechanism of transfer.

a triplet code is revealed (e.g. CAT), a tRNA with the complementary GTA triplet will bind to it and bring the specific amino acid coded by that triplet. The growing peptide chain will then be grafted on to that amino acid (Fig. 6.20). The rRNA will shift along the chain to reveal the next triplet and so the process continues until the whole strand is read. The new protein is then released from rRNA which is now available to start the process (translation) again.

6.4 Drugs acting on RNA

Several antibiotic agents are capable of acting on RNA molecules and interfering with transcription and translation. These are discussed in Chapter 10.

6.5 Summary

In this chapter we have considered drugs which act on transcription, translation, and replication by acting *directly* on DNA and RNA. There are other drugs (e.g. nalidixic acid) which affect these processes, but since these drugs work by inhibiting enzymes rather than by a direct interaction with DNA or RNA, they have not been mentioned here.

7 ■ Drug development

For several thousand years, man has used herbs and potions as medicines, but it is only since the mid-nineteenth century that serious efforts were made to isolate and purify the active principles of these remedies. Since then, a large variety of biologically active compounds have been obtained and their structures determined (e.g. morphine from opium, cocaine from coca leaves, quinine from the bark of the cinchona tree).

These natural products became the lead compounds for a major synthetic effort where chemists made literally thousands of analogues in an attempt to improve on what Nature had provided. The vast majority of this work was carried out with no real design or reason, but out of the results came an appreciation of certain tactics which generally worked. A pattern for drug development evolved. This chapter attempts to show what that pattern is and the useful tactics which can be employed for developing drugs.

. Nowadays, the development of a novel drug from natural sources might follow the following pattern.

- Screening of natural compounds for biological activity.
- Isolation and purification of the active principle.
- Determination of structure.
- Structure–activity relationships (SARs).
- Synthesis of analogues.
- Receptor theories.
- Design and synthesis of novel drug structures.

7.1 *Screening of natural products*

The screening of natural products became highly popular following the discovery of penicillin from a mould. Plants, fungi, and bacterial strains were collected from all round the world in an effort to find other metabolites with useful biological activities. This led in particular to an impressive arsenal of antibacterial agents (Chapter 9).

Screening of natural products from plant and microbial sources continues today in

the never-ending quest to find new lead compounds. In recent years, organisms from marine sources have given novel compounds with interesting biological activity and this is a field likely to expand.

7.2 Isolation and purification

The ease with which the active principle can be isolated and purified depends very much on the structure, stability, and quantity of the compound.

Penicillin proved a difficult compound to isolate and purify. Although Fleming recognized the antibiotic qualities of penicillin and its remarkable non-toxic nature to man, he disregarded it as a useful drug since it appeared too unstable. He could isolate it in solution, but whenever he tried to remove the solvent, the drug was destroyed. Now that we know the structure of penicillin (Chapter 9), its instability under the purification procedures of the day is understandable and it was not until the development of a new procedure called freeze-drying that a successful isolation of penicillin was achieved.

Other advances in isolation techniques have occurred since those days and in particular in the field of chromatography. There are now a variety of chromatographic techniques available to help in the isolation and purification of a natural product.

7.3 Structure determination

In the past, determining the structure of a new compound was a major hurdle to overcome. It is sometimes hard for present-day chemists to appreciate how difficult structure determinations were before the days of NMR and IR spectroscopy. A novel structure which may now take a week's work to determine would have provided two or three decades of work in the past. For example, the microanalysis of cholesterol was carried out in 1888 to get its molecular formula, but its chemical structure was not fully established until an X-ray crystallographic study was carried out in 1932.

Structures had to be degraded to simpler compounds, which were further degraded to recognizable fragments. From these scraps of evidence, possible structures were proposed, but the only sure way of proving the theory was to synthesize these structures and to compare their chemical and physical properties with those of the natural compound or its degradation products.

Today, structure determination is a relatively straightforward process and it is only when the natural product is obtained in minute quantities that a full synthesis is required to establish its structure.

In cases where there is not enough sample for an IR or NMR analysis, mass spectroscopy can be helpful. The fragmentation pattern can give useful clues about

the structure, but it does not, however, prove the structure. A full synthesis is still required as final proof.

Vinblastine (Fig. 7.1), an alkaloid used against advanced teratomas and lymphomas, is an example of how complex the structures of natural products can be. However, analytical skills and instruments have advanced to such an extent that even this structure is relatively simple compared to some of the natural product structures being studied today.

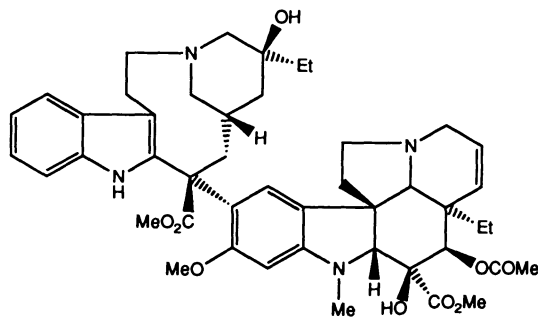

Fig. 7.1 Vinblastine.

today.

7.4 Structure–activity relationships

Once the structure of a biologically active compound is known, the medicinal chemist is ready to move on to study the structure–activity relationships of the compound.

The aim of such a study is to discover which parts of the molecule are important to biological activity and which are not. The chemist makes a selected number of compounds, which vary slightly from the original molecule, and studies what effect that has on the biological activity.

One could imagine the drug as a chemical knight entering the depths of a forest (the body) in order to make battle with an unseen dragon (the body's affliction) (Fig. 7.2). The knight (Sir Drugalot) is armed with a large variety of weapons and armour, but since his battle with the dragon goes unseen, it is impossible to tell which weapon he uses or whether his armour is essential to his survival. We only know of his success if he returns unscathed with the dragon slain. If the knight declines to reveal how he slew the dragon, then the only way to find out how he did it would be to remove some of his weapons and armour and to send him in against other dragons to see if he can still succeed.

As far as a drug is concerned, the weapons and armour are the various chemical functional groups present in the structure, which can bind to the receptor or enzyme. We have to be able to recognize these functional groups and determine which ones are important.

Let us imagine that we have isolated a natural product with the structure shown in Fig. 7.3. We shall name it Glipine. There are a variety of groups present in the structure and the diagram shows the potential bonding interactions which are possible with a receptor.

It is unlikely that all of these interactions take place, so we have to identify those which do. By synthesizing compounds (such as the examples shown in Fig. 7.4) where

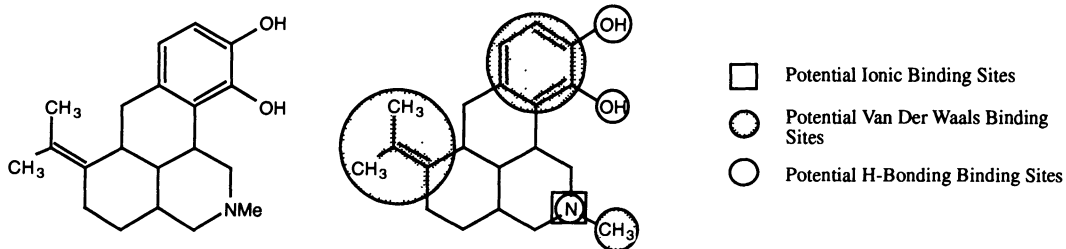

Fig. 7.3 Glipizine.

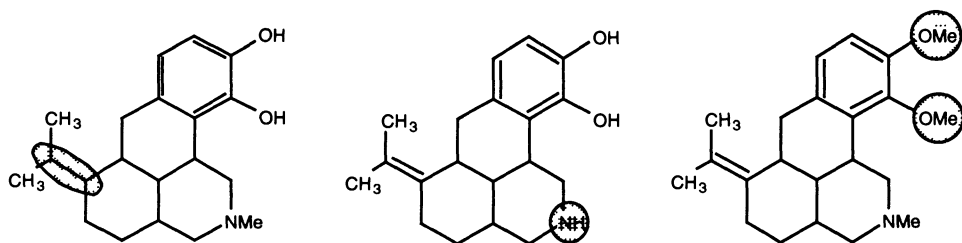

Fig. 7.4 Modifications of glipizine.

one particular group of the molecule is removed or altered, it is possible to find out which groups are essential and which are not.

The ease with which this task can be carried out depends on how easily we can carry out the necessary chemical transformations to remove or alter the relevant group. For example, the importance or otherwise of an amine group is relatively easy to establish, whereas the importance of an aromatic ring might be more difficult. Hydroxyl groups, amino groups, and aromatic rings are particularly common binding groups in medicinal chemistry, so let us consider what analogues could be synthesized to establish whether they are involved or not.

7.4.1 The binding role of hydroxyl groups

Hydroxyl groups are commonly involved in hydrogen bonding. Converting such a group to a methyl ether or an ester is straightforward (Fig. 7.5) and will usually destroy or weaken such a bond.

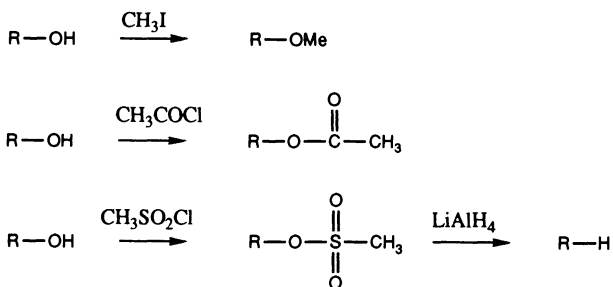

Fig. 7.5 Conversions of hydroxyl groups.

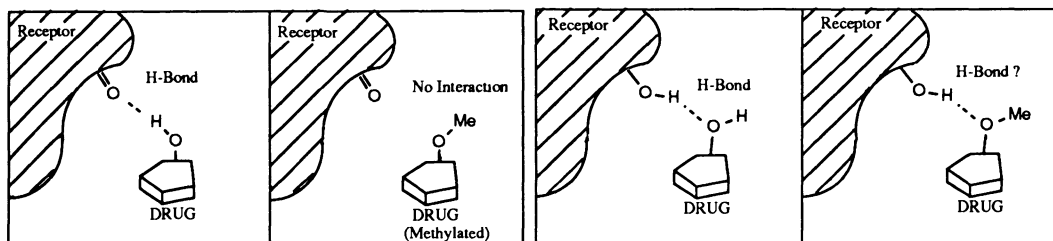

Fig. 7.6 Possible hydrogen bond interactions.

There are several possible explanations for this. The obvious explanation is that the proton of the hydroxyl group is involved in the hydrogen bond to the receptor and if it is removed, the hydrogen bond is lost (Fig. 7.6). However, suppose it is the oxygen atom which is hydrogen bonding to a suitable amino acid residue?

The oxygen is still present in the ether or the ester analogue, so could we really expect there to be any effect on hydrogen bonding? Well, yes we could. The hydrogen bonding may not be completely destroyed, but we could reasonably expect it to be weakened, especially in the case of an ester.

The reason is straightforward. When we consider the electronic properties of an ester compared to an alcohol, then we observe an important difference. The carboxyl group can 'pull' electrons from the neighbouring oxygen to give the resonance structure shown in Fig. 7.7. Since the lone pair is involved in such an interaction, it cannot take part so effectively in a hydrogen bond.

Steric factors also count against the hydrogen bond. The extra bulk of the acyl group will hinder the close approach which was previously attainable.

This steric hindrance also explains how a methyl ether could disrupt hydrogen bonding.

If there is still some doubt over whether a hydroxyl group is involved in hydrogen

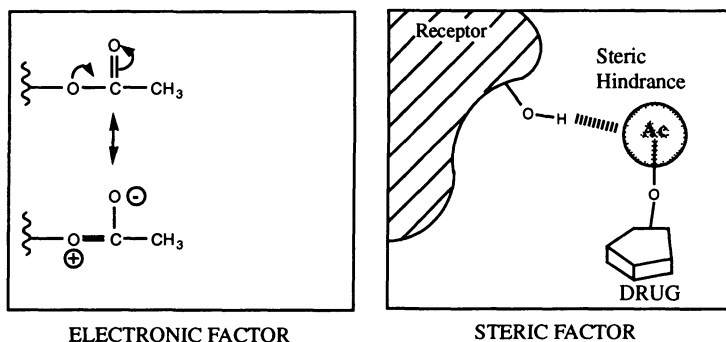

Fig. 7.7 Factors by which an ester group can disrupt hydrogen bonding.

bonding or not, it could be replaced with an isosteric group such as methyl (see later). This would be more conclusive, but synthesis is more difficult.

Another possibility is to react the hydroxyl group with methanesulfonyl chloride followed by lithium aluminum hydride (Fig. 7.5). This would replace the hydroxyl with a proton, but any group which is prone to reduction would have to be protected first.

7.4.2 The binding role of amino groups

Amines may be involved in hydrogen bonding or ionic bonding, but the latter is more common. The same strategy used for hydroxyl groups works here too. Converting the amine to an amide will prevent the nitrogen's lone pair taking part in hydrogen bonding or taking up a proton to form an ion.

Tertiary amines have to be dealkylated first, before the amide can be made. Dealkylation is normally carried out with cyanogen bromide or a chloroformate such as vinylloxycarbonyl chloride (Fig. 7.8).

Fig. 7.8 Dealkylation of tertiary amines.

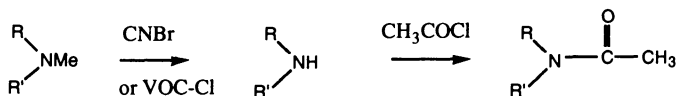

7.4.3 The binding role of aromatic rings

Aromatic rings are commonly involved in van der Waals interactions with flat hydrophobic regions of the binding site. If the ring is hydrogenated to a cyclohexane ring, the structure is no longer flat and interacts far less efficiently with the binding site (Fig. 7.9).

Fig. 7.9 Reduction in the binding efficiency of aromatic rings by hydrogenation.

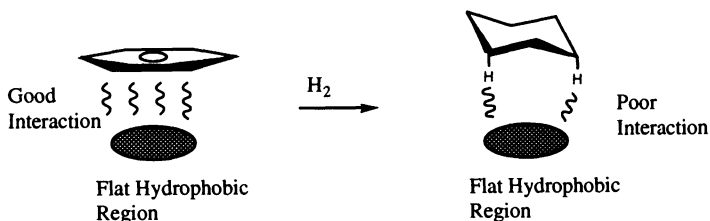

However, carrying out the reduction may well cause problems elsewhere in the structure, since aromatic rings are difficult to reduce and need forcing conditions.

Replacing the ring altogether with a bulky alkyl group could reduce van der Waals bonding for the same reason given above, but obtaining such compounds could involve a major synthetic effort.

7.4.4 The binding role of double bonds

Unlike aromatic rings, double bonds are easy to reduce and this has a significant effect on the shape of that part of the molecule. The planar double bond is converted into a bulky alkyl group.

If the original alkene was involved in van der Waals bonding with a flat surface on the receptor, reduction should weaken that interaction, since the bulkier product is less able to approach the receptor surface (Fig. 7.10).

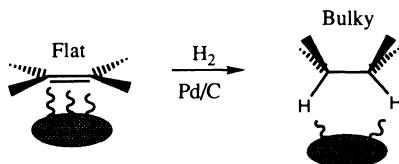

Fig. 7.10 The binding role of double bonds.

Once it is established which groups are important for a drug's activity, the medicinal chemist can move on to the next stage—the synthesis of analogues which still contain these essential features.

7.5 Synthetic analogues

Why is this stage necessary? If a natural compound such as our hypothetical Glipine has useful biological activity, why bother making synthetic analogues? The answer is that very few drugs are ideal. Many have serious side-effects and there is a great advantage in finding analogues which lack them. In general, the medicinal chemist is developing drugs with three objectives in mind:

- to increase activity
- to reduce side-effects
- to provide easy and efficient administration to the patient

Drug development in the past has mostly been a hit or a miss affair with a large number of compounds being synthesized at random. Luck has played a great part, but we can now recognize strategies which have evolved over the years:

- variation of substituents
- extension of the structure
- chain extensions/contractions
- ring expansions/contractions
- ring variations
- isosteres
- simplification of the structure
- rigidification of the structure

7.5.1 Variation of substituents

Once the essential groups for biological activity have been identified, substituents are varied since this is usually quite easy to do synthetically. The aim here is to fine tune the molecule and to optimize its activity. Biological activity may depend not only on how well the compound interacts with its receptor, but also on a whole range of physical features such as basicity, lipophilicity, electronic distribution, and size (see Chapter 8). The idea of varying substituents is to attach a series of substituents such that these physical features are varied one by one. In reality, it is rarely possible to change one physical feature without affecting another. For example, replacing a methyl group on a nitrogen with an ethyl group could affect the basicity of the nitrogen atom, but the size of the molecule is also increased. Either of these changes might have an effect on the activity of a drug and it would be difficult to know which was more important without more results.

The following are routine variations which can be carried out.

Alkyl substituents

If the molecule has an easily accessible functional group such as an alcohol, phenol, or amino group, then alkyl chains of various lengths and bulks such as methyl, ethyl, propyl, butyl, isopropyl, isobutyl or *tert*-butyl can be attached.

Different alkyl groups on a nitrogen atom may alter the basicity and/or lipophilicity of the drug and thus affect how strongly the drug binds to its binding site or how easily the compound crosses membrane barriers (see Chapter 8).

Larger alkyl groups, however, increase the bulk of the compound and this may confer selectivity on the drug. For example, in the case of a compound which interacts with two different receptors, a bulkier alkyl substituent may prevent the drug from binding to one of those receptors and so cut down side-effects (Fig. 7.11).

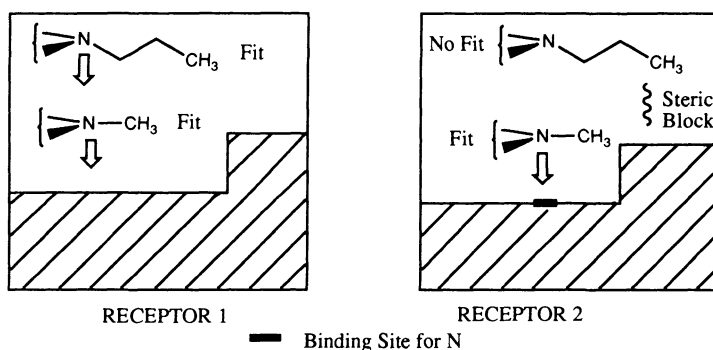

Fig. 7.11 Use of a larger alkyl group to confer selectivity on a drug.

Aromatic substitutions

A favourite approach for aromatic compounds is to vary the substitution pattern. This may give increased activity if the relevant binding groups are not already in the ideal positions for bonding (Fig. 7.12).

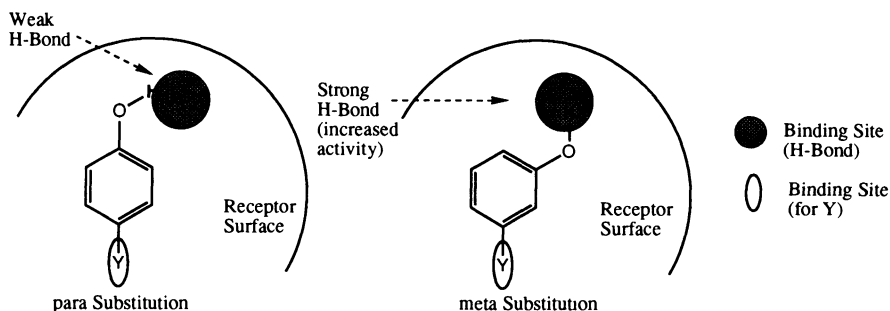

Fig. 7.12 Aromatic substitutions.

Electronic effects may also be involved. For example, an electron withdrawing nitro group will affect the basicity of an aromatic amine more significantly if it is in the *para* position rather than the *meta* position (Fig. 7.13). We have noted already that varying the basicity of a nitrogen atom may have a biological effect.

If the substitution pattern is ideal, then we can try varying the substituents themselves. Substituents of different sizes and electronic properties are usually tried to see if steric and electronic factors have any effect on activity. It may be that activity is improved by having a more electron withdrawing substituent, in which case a nitro substituent might be tried in place of a chloro substituent.

The chemistry involved in these procedures is usually straightforward and so these analogues are made as a matter of course whenever a novel drug structure is dis-

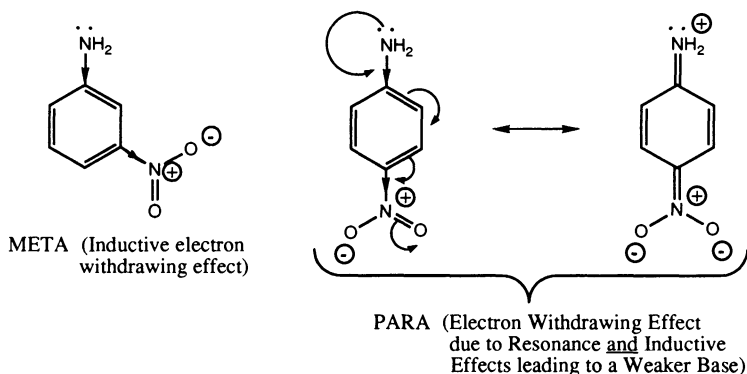

Fig. 7.13 Electronic effects of aromatic substitutions.

covered or developed. Furthermore, the variation of aromatic or aliphatic substituents is open to quantitative structure–activity studies (QSARs) as described in Chapter 9.

7.5.2 Extension of the structure

This strategy has been used successfully on natural products such as morphine. It might seem strange that a natural product which is produced in a plant or a fungus should have important biological effects in the human body. One possible explanation for this could be that the natural product is present in the body as well. However, this seems unlikely. Therefore, we have to conclude that it is a happy coincidence that morphine has the right shape and binding groups to interact with a painkilling receptor in the body. This leads to some interesting conclusions.

Since there is a painkilling receptor in the body we have to accept that there is a neurotransmitter (or hormone) which switches on that receptor. We already know that it cannot be morphine, so the painkilling molecule has to have a different shape and possibly different binding groups. Assuming that the body's own painkiller is the ideal molecule for its receptor, then we must also conclude that morphine is not the ideal molecule. For example, it is perfectly possible that the natural painkiller has four important binding interactions with its receptor, whereas morphine has only three (Fig. 7.14). Therefore, why not add binding groups to the morphine skeleton to search for that fourth binding site? This tactic has been employed successfully to produce compounds such as the phenethyl analogue of morphine which has 14 times greater activity. Such a result suggests that the extra binding site on the receptor is hydrophobic, interacting with the aromatic ring by van der Waals interactions.

Frequently, this extension tactic has resulted in a compound which acts as an antagonist rather than as an agonist. In this case, the extra binding site is not one used

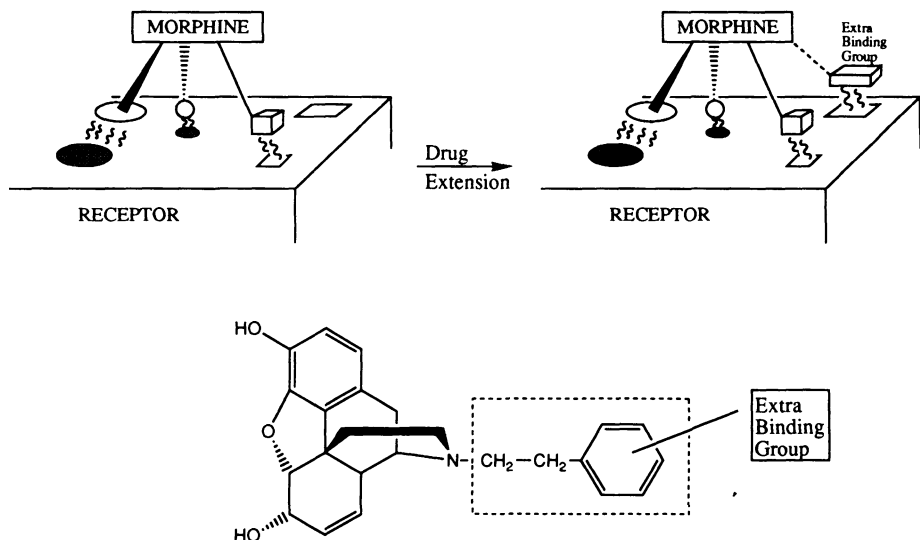

Fig. 7.14 Extension of morphine to provide a fourth binding group.

by the natural agonist or substrate. The binding interaction is different and no biological response results.

7.5.3 Chain extensions/contractions

Some drugs have two important binding groups linked together by a chain. Many of the natural neurotransmitters are like this. It is possible that the chain length is not ideal for the best interaction. Therefore, shortening or lengthening the chain length is a useful tactic to try (Fig. 7.15).

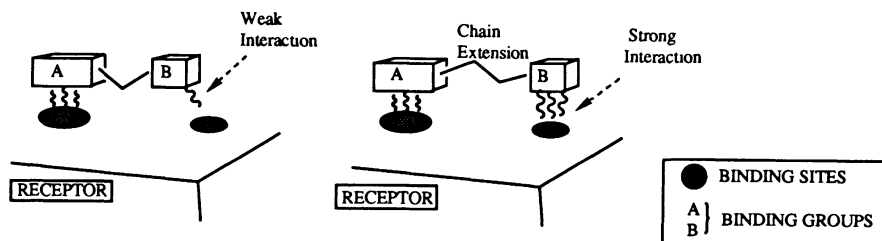

Fig. 7.15 Chain extension.

7.5.4 Ring expansions/contractions

If a drug has a ring, it is generally worth synthesizing analogues where one of these rings is expanded or contracted by one unit. The principle behind this approach is much the same as varying the substitution pattern of an aromatic ring. Expanding or contracting the ring puts the binding groups in different positions relative to each other and, with luck, may lead to better interactions with the binding site (Fig. 7.16).

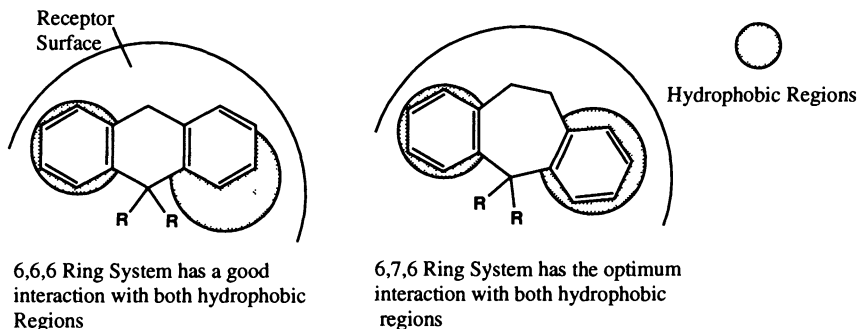

Fig. 7.16 Ring expansion.

7.5.5 Ring variations

A further popular approach for compounds containing an aromatic ring is to try replacing the aromatic ring with a range of heteroaromatic rings of different ring size and heteroatom positions. Admittedly, a lot of these changes are merely ways of

avoiding patent restrictions and do not result in significant improvements, but sometimes there are significant advantages in changing a ring system.

One of the major advances in the development of the selective beta blockers was the replacement of the aromatic ring in adrenaline with a naphthalene ring system (pronethalol) (Fig. 7.17). This resulted in a compound which was able to distinguish between two very similar receptors, the alpha and beta receptors for adrenaline. One possible explanation for this could be that the beta receptor has a larger van der Waals binding area for the aromatic system than the alpha receptor and can interact more strongly with pronethalol than with adrenaline. Another possible explanation is that the naphthalene ring system is sterically too big for the alpha receptor but is just right for the beta receptor.

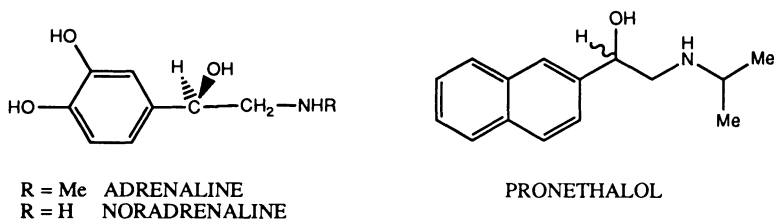

Fig. 7.17 Ring variation of adrenaline.

7.5.6 Isosteres

Isosteres are atoms or groups of atoms which have the same valency (or number of outer shell electrons). For example, SH, NH₂, and CH₃ are isosteres of OH, while S, NH, and CH₂ are isosteres of O. Isosteres have often been used to design an inhibitor or to increase metabolic stability. The idea is to alter the character of the molecule in as subtle a way as possible. Replacing O with CH₂, for example, will make little difference to the size of the analogue, but will have a marked effect on its polarity, electronic distribution, and bonding. Replacing OH with the larger SH may not have such an influence on the electronic character, but steric factors become more significant.

Isosteric groups could be used to determine whether a particular group is involved in hydrogen bonding. For example, replacing OH and CH₃ would completely destroy hydrogen bonding, whereas replacing OH with NH₂ would not.

The beta blocker propranolol has an ether linkage (Fig. 7.18). Replacement of the OCH₂ segment with the isosteres CH=CH, SCH₂, or CH₂CH₂ eliminates activity, whereas replacement with NHCH₂ retains activity (though reduced). These results show that the ether oxygen is important to the activity of the drug and suggests that it is involved in hydrogen bonding with the receptor.

Replacing the methyl of a methyl ester group with NH₂ has been a useful tactic in stabilizing esters which are susceptible to enzymatic hydrolysis (Fig. 7.19). The NH₂

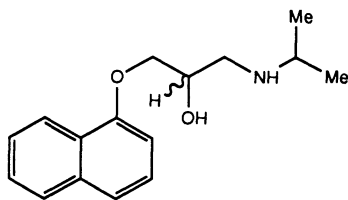

Fig. 7.18 Propranolol.

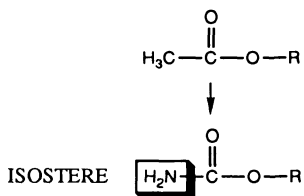

Fig. 7.19 Isosteric replacement of a methyl with an amino group.

group is the same size as the methyl and therefore has no steric effect. However, it has totally different electronic properties, and as such can feed electrons into the carboxyl group and stabilize it from hydrolysis (see Chapter 11).

Although fluorine does not have the same valency as hydrogen, it is often considered an isostere of that atom since it is virtually the same size. Replacement of a hydrogen atom with a fluorine atom will therefore have little steric effect, but since the fluorine is strongly electronegative, the electronic effect may be dramatic.

The use of fluorine as an isostere for hydrogen has been highly successful in recent years. One example is the antitumour drug 5-fluorouracil described in Section 4.5.3. The drug is accepted by the target enzyme since it appears little different from the normal substrate (uracil). However, the mechanism of the enzyme-catalysed reaction is totally disrupted. Fluorine has replaced a hydrogen atom which must be lost as a proton during the mechanism. There is no chance of fluorine departing as a positively charged species.

7.5.7 Simplification of the structure

If the essential groups of a drug have been identified, then by implication, it might be possible to discard non-essential parts of the structure without losing activity. The advantage would be in gaining a far simpler compound which would be much easier and cheaper to synthesize in the laboratory. For example, let us consider our hypothetical natural product Glipine (Fig. 7.20). The essential groups have been marked and so we might aim to synthesize compounds such as those shown in Fig. 7.20. These have simpler structures, but still retain the groups which we have identified as being essential.

This tactic was used successfully with the alkaloid cocaine (Fig. 7.21). It was well known that cocaine had local anaesthetic properties and it was hoped to develop a local anaesthetic based on a simplified structure of cocaine which could be easily synthesized in the laboratory. Success resulted with the discovery of procaine (or Novocaine) in 1909.

However, there is a trade-off involved when simplifying molecules. The advantage in obtaining simpler compounds may be outweighed by the disadvantage of increased

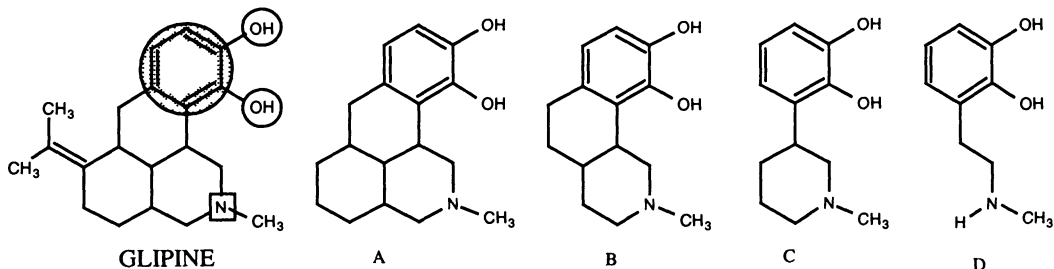

Fig. 7.20 Glipine analogues.

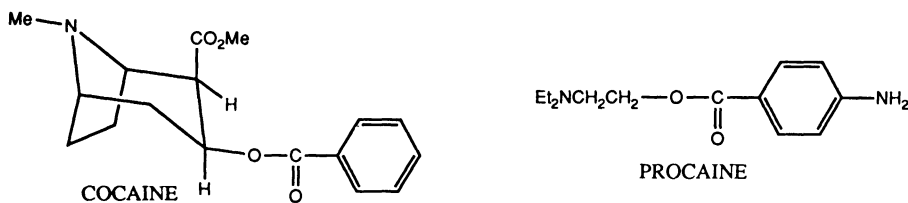

Fig. 7.21 Cocaine and procaine.

side-effects and reduced selectivity. We shall see below how these undesirable properties can creep in with simpler molecules and why the opposite tactic of rigidification can be just as useful as that of simplification.

7.5.8 Rigidification of the structure

Rigidification has been a popular tactic used to increase the activity of a drug or to reduce its side-effects. In order to understand why, let us consider again our hypothetical neurotransmitter from Chapter 5 (Fig. 7.22). This is quite a simple molecule and highly flexible. Bond rotation can lead to a large number of conformations or shapes. However, as seen from the receptor/messenger interaction, conformation I is the conformation accepted by the receptor. Other conformations such as II have the ionized amino group too far away from the anionic centre to interact efficiently and so this is an inactive conformation for our model receptor site. However, it is quite possible that there exists a different receptor which is capable of binding conformation II. If this is the case, then our model neurotransmitter could switch on two different receptors and give two different biological responses.

The body's own neurotransmitters are highly flexible molecules (Chapter 5), but fortunately the body is quite efficient at releasing them close to their target receptors, then quickly inactivating them so that they do not make the journey to other receptors. However, this is not the case for drugs. They have to be sturdy enough to travel through the body and consequently will interact with all the receptors which are prepared to accept them. The more flexible a drug molecule is, the more likely it will

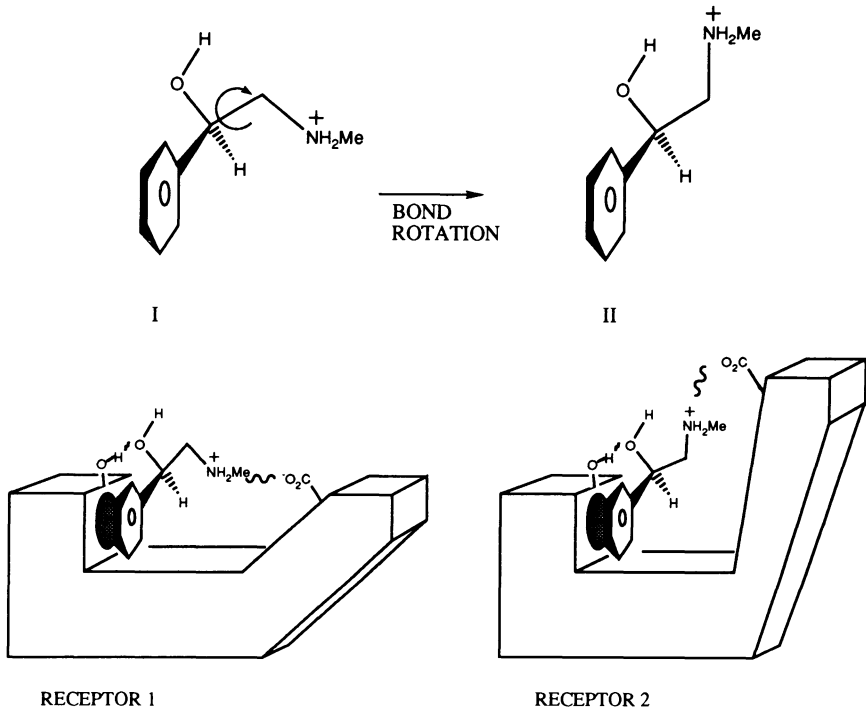

Fig. 7.22 Two conformations of a neurotransmitter which are capable of binding with different receptors.

interact with more than one receptor and produce other biological responses (side-effects).

The strategy of rigidification is to 'lock' the drug molecule into a more rigid conformation such that it cannot take up these other shapes or conformations. Consequently, other receptor interactions and side-effects are eliminated. This same strategy should also increase activity since, by locking the drug into the active conformation, the drug is ready to fit its target receptor site more readily and does not need to 'find' the correct conformation. Incorporating the skeleton of a flexible drug into a ring is the usual way of 'locking' a conformation and so for our model compound the analogue shown in Fig. 7.23 would be suitably rigid.

The sedative etorphine (Fig. 7.24) was designed by this approach (Chapter 12).

7.6 Receptor theories

The synthesis of a large number of analogues not only gives compounds with improved activity and reduced side-effects, but can also give information about the protein with which the drugs interact. Clearly, if a drug has an important binding

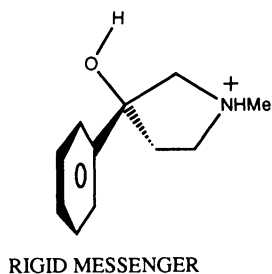
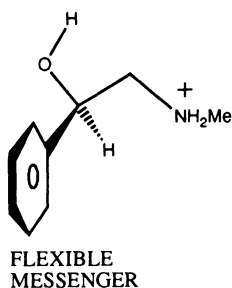

Fig. 7.23 Rigidification of the hypothetical neurotransmitter.

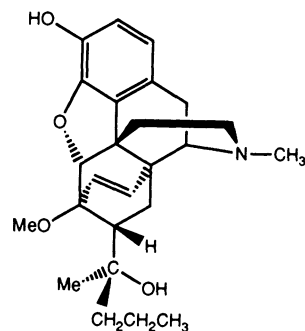

Fig. 7.24 Etorphine.

group, there must be a complementary binding group present in the binding site of the receptor or enzyme.

A 3D model of the binding site containing these complementary groups could then be built. With such a model, it would be possible to predict whether new analogues would have activity. Before the age of computers, this was not an easy task, and the best one could do was to build models of the drugs themselves and to match them up to see how similar they were. This is clearly unsatisfactory, since it is impossible to superimpose one solid object on another.

The introduction of computer graphics changed all that and revolutionized the field of medicinal chemistry such that the goal of rational, scientific drug design is now feasible.

At the simplest level, the computer can be used to compare drugs and to see how similar they are. The structures are built on the screen and displayed in a form suited to the operator. They can be viewed as ball-and-stick models or as space-filled models. Each model can be colour coded, then superimposed on each other to see how well they match up. The operator can then rotate the superimposed models to study them from different angles and then accurately measure important distances and angles. By doing this, the 'pharmacophore' can be determined for a particular group of drugs. The pharmacophore is the relative position of the important groups and ignores the molecular skeleton which holds them in position. The skeleton is considered irrelevant unless it sterically prevents the molecule from fitting the receptor site. In theory, all drugs acting in the same way and on the same receptor/enzyme should have the same pharmacophore.

However, this approach is not very satisfactory especially when dealing with flexible molecules which can take up various conformations. The computer is clever, but it is not a miracle worker. It has no way of knowing which conformation the drugs will adopt to fit the binding site, and so the structures which are built and energy-minimized on the screen will be constructed such they have the most stable conformation, not necessarily the most active conformation.

One way round this is to compare drugs against a rigid molecule (usually an antagonist) which binds to the receptor site and contains the pharmacophore within its skeleton. It is then assumed that more flexible drugs take up the conformation which most closely matches this pharmacophore.

However, the computer is capable of more powerful things.

An X-ray structure of a receptor or protein is of enormous benefit to the whole modelling process, since the X-ray data can be fed into the computer to build a 3D space-filled model of the macromolecule.

Unfortunately, this does not reveal where the active site or binding site is and so it is better to get an X-ray structure of the macromolecule with an antagonist irreversibly bound to the binding site. The antagonist then acts as a label for the binding site.

Once the protein is on the computer screen, the computer operator can peel away layers until a cross-sectional view of the binding site is revealed.

Drugs both known and planned can then be introduced to see whether they fit. Substituents and conformations can be changed at will to see whether or not the fit is improved. By doing each studies, it is possible to rule out a number of proposed new structures and so cut down the amount of synthetic work to be done in the laboratory. For it is important to realize that computers, powerful though they may be, are unlikely to replace the bench chemist. Compounds still have to be made to test the theories.

The computer can be used to study molecular features which cannot be studied in any other way.

For example, electron densities can be calculated throughout the molecule and displayed as numbers or by colour coding. This will show areas of high and low electron density in the molecule and can be compared with similar areas in the binding site. This is a far more scientific approach to the study of ionic interactions than just comparing a positively charged nitrogen atom bound to a negatively charged carboxylate anion, where both species are fixed at one point in space.

These quantum mechanical calculations have led to rather startling results which challenge the chemist's traditional viewpoint of charged molecules. For example, the calculated electronic distribution for ionized histamine is shown in Fig. 7.25. The numbers in each sphere represent the overall charge of that sphere (i.e. electronic charge minus nuclear charge). In this calculation, the electron density outwith these spheres is not included, which is why the numbers do not add up to +1. This is not important. What is important are the relative values of the charge throughout the molecule.

Conventionally, the chemist would consider the positive charge to be localized on the nitrogen atom. However, the calculations above show that the charge has been spread over the molecule and that the nitrogen atom is no more positively charged than neighbouring carbon atoms. This has important consequences to the way we

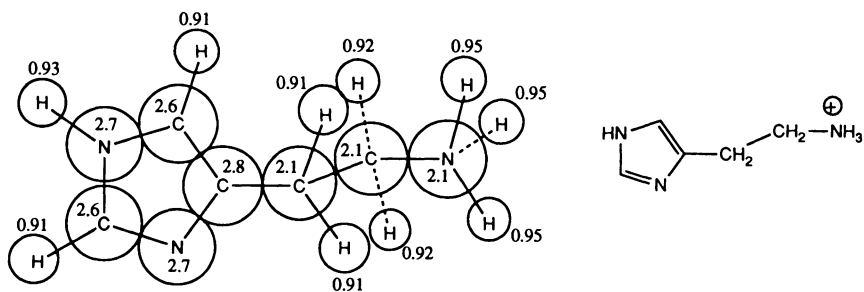

Fig. 7.25 Histamine.

think of ionic interactions between drugs and receptors. It implies that charged areas both on the receptor and the drug are more diffuse than originally thought. This suggests that we have wider scope in designing novel drugs. For example, in the classical viewpoint of charge distribution, a certain molecule might be considered to have its charged centre too far away from the corresponding 'centre' in the receptor binding site. If these charged areas are actually more diffuse, then this assumption is false (Fig. 7.26).

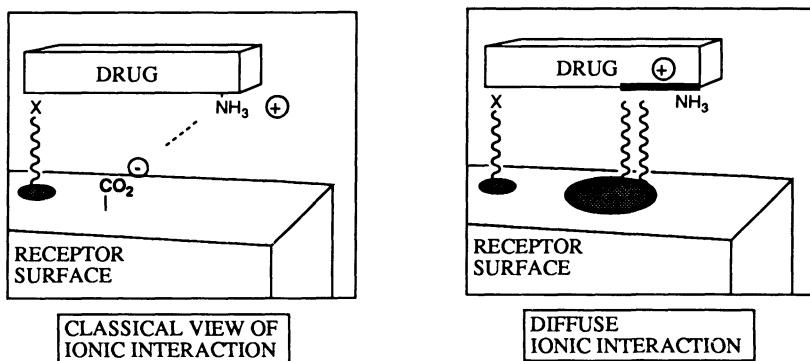

Fig. 7.26 Ionic interactions.

It is worth pointing out, however, that the above calculations were carried out on a histamine structure in isolation from its environment. In the body, histamine is in an aqueous environment and would be surrounded by water molecules which would solvate the charge and consequently have an effect on charge distribution.

If an X-ray structure of a protein is not available, we are thrown back to designing a theoretical binding site based on the structures of the compounds which interact with it. This, of course, introduces the uncertainty of which conformations are adopted by flexible molecules. One cannot assume that the most stable conformation is adopted, since the energy gained from bonding interactions between protein and drug may be

sufficient to force the drug into a less favoured conformation. This complicates the mapping of receptor sites, since it means that all reasonable conformations of the drug have to be considered.

Despite this, programmes have been designed to try and solve these problems.

For example, by considering the various conformations of a range of active compounds, it is possible to find the common volume or space into which the active compounds can be placed in order to interact with the receptor. These 'spaces' can then be compared with 'no go areas'—areas which must not be occupied. These areas are determined by considering similar structures which do not fit the binding site. By subtracting one from the other, a more accurate shape or volume is obtained, which, in turn, can reveal which conformations are not permitted for active drugs. Clearly, the more drugs studied, the more accurate the picture.

These achievements have now resulted in a new phase of drug development whereby the chemist can design completely new structures totally unrelated to the structure of the original compounds. Put simply, the chemist can ensure that the important groupings are still present, but design a totally new framework to hold them in the correct positions. Rather than research being directed by the original drug, research is now directed by the receptor which the scientist wants to influence.

A warning! It is important to appreciate that the computer graphic studies described above are tackling only one part of a much bigger problem—the design of an *effective* drug. True, one could design the perfect compound for a particular enzyme or receptor, but if the compound never reaches the target protein in the body, it is a useless drug. The various hurdles and obstacles which a drug has to overcome are described in Chapter 8, but for the moment, we should appreciate that these hurdles are many and varied, and that there is no way of predicting whether a particular compound will win through to its target site.

Therefore, finding the ideal drug for a protein target is still only part of the overall battle. A great deal of fine-tuning still requires to be done, and the compound with the most effective interactions at the protein target will not necessarily be the most effective drug.

7.7 The elements of luck and inspiration

It is true to say that drug design is becoming more rational, but it has not yet eliminated the role of chance or the need for hard-working, mentally alert bench chemists.

The vast majority of drugs still on the market were developed by a mixture of rational design, trial and error, hard graft, and pure luck. The drugs which were achieved by purely rational design are severely limited and are exemplified by cimetidine (Chapter 13) and pralidoxime (Chapter 11).

Frequently, the development of drugs has been based on 'ringing the changes', watching the literature to see what works on related compounds and what doesn't, then trying out similar alterations to one's own work. It is very much a case of groping in the dark, with the chemist asking whether adding a group at a certain position will have a steric effect, an electronic effect, or a bonding effect.

Even when drug design is followed on rational lines, good fortune often has a role to play.

The development of the beta blocker propranolol (Fig. 7.27) was aided by such a slice of good fortune. Chemists at ICI were trying to improve on a drug called pronethalol (Fig. 7.17), the first beta blocker to reach the market. It was known that the naphthalene ring and the ethanolamine segment were important both to activity and selectivity, so these groups had to be retained. Therefore, it was decided to study what would happen if the distance between these two groups was extended. Perhaps by doing so, the two groups would interact with their respective binding sites more efficiently.

Various segments were to be inserted, one of which was the OCH_2 moiety. The analogue which would have been obtained is shown as structure I in Fig. 7.27. β -Naphthol was the starting material, but was not immediately available, and rather than waste the day, α -naphthol was used instead. The result was propranolol which has proved a successful drug in the treatment of angina for many years.

When the original target was eventually made, it showed little improvement over the original compound—pronethalol.

A further interesting point concerning this work is that the propranolol skeleton had been synthesized some years earlier. However, the workers involved had not been searching for beta blocking activity and had not recognized the potential of the compound.

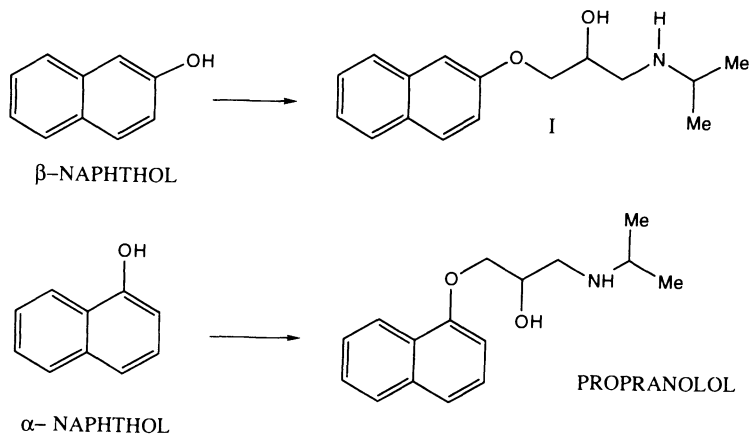

Fig. 7.27 The development of the beta-blocker propranolol.

This point emphasizes the importance of keeping an open mind, especially when testing for biological activity. Frequently, an analogue made in one field of medicinal chemistry is found to have an unexpected application in another field altogether.

Alternatively, work carried out in order to solve a specific problem in a certain field may produce a compound which solves a completely different problem in the same field. Once again, the beta blockers provide an illustration of this. We have seen how propranolol and its analogues are effective beta blocking drugs. However, they are also lipophilic, which means that they can enter the CNS (central nervous system) and cause side-effects. In an attempt to cut down this entry into the CNS, it was decided to add a hydrophilic amide group to the molecule and so inhibit passage through the blood brain barrier. One of the compounds made was practolol (Fig. 7.28). As expected, this compound had less CNS side-effects, but more importantly, it was found to be a selective antagonist for the beta receptors of the heart over beta receptors in other organs—a result that was highly desirable, but not the one that was being looked for at the time.

7.8 Lead compounds

In order to design a drug with a particular biological activity, the medicinal chemist requires a lead compound—a compound which shows a useful pharmaceutical activity. The level of activity may not be very great and there may be undesirable side-effects, but the lead compound provides a start. By altering the structure using the strategies already mentioned, a useful drug may be developed with improved activity and reduced side-effects. Lead compounds are often found from natural sources or herbs used in traditional medicine, but these are not the only sources. Pharmaceutical companies routinely screen a large variety of novel compounds synthesized in industrial and academic laboratories. These compounds may be intermediates in a purely synthetic research study, but there is always the chance that they may have useful biological activity.

On occasions, the useful biological activity may only be a minor property or a side-effect of a compound. The aim then would be to enhance the side-effect and eliminate the major biological activity. The story of the antiulcer agent cimetidine (Fig. 7.29) is a case in point. The desired biological property was selective *antagonism* of histamine receptors in the stomach. The lead compound was a histamine *agonist* with a very weak antagonism for the receptors of interest.

In such situations, the medicinal chemist wants to alter the molecule such that the major biological activity is eliminated and the side-effect is boosted until it becomes the dominant effect. Once this has been achieved, the drug can be 'fine-tuned' as

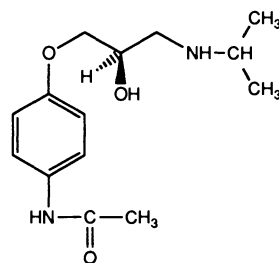

Fig. 7.28 Practolol.

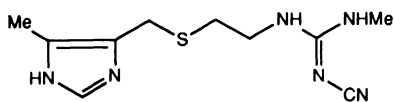

Fig. 7.29 Cimetidine.

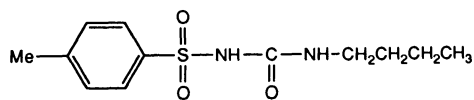

Fig. 7.30 Tolbutamide.

described above. Clearly, this is a more demanding objective, but the cimetidine story proves that it is attainable (Chapter 13).

A further example is provided by the antidiabetic agent tolbutamide (Fig. 7.30) which was developed from a sulfonamide structure. Most sulfonamides are used as antibacterial agents, but some proved unsatisfactory since they led to convulsions brought on by hypoglycaemia (low glucose levels in the blood). Structural alterations were made to eliminate the antibacterial activity and to enhance the hypoglycaemic activity and this led to tolbutamide.

The moral of the story is that an unsatisfactory drug in one field may provide the lead compound for another field. It is not a good idea to think of a structural group of compounds as having only one type of biological activity. The sulfonamides are generally thought of as antibacterial agents, but we have seen that they can have other properties as well.

7.9 A case study—oxamniquine

The above tactics need not necessarily be used in the order given. We shall see this in the following example—the development of oxamniquine (Fig. 7.31).

Oxamniquine is an important Third World drug used in the treatment of schistosomiasis (bilharzia). This disease affects an estimated two hundred million people and is contracted by swimming or wading in infected water. The disease is carried by a snail which can penetrate human skin and enter the blood supply. There, it produces eggs which become trapped in organs and tissues, and this in turn leads to the symptoms of the disease.

The first stage in the development of oxamniquine was to find a lead compound, and so a study was made of compounds which were active against the parasite. The tricyclic structure lucanthone (Fig. 7.32) was chosen. It was known to be effective against some forms of the disease, but it was also toxic and had to be injected at regular intervals to remain effective. Therefore, the goal was to increase the activity of the drug, broaden its activity, reduce side-effects, and make it orally active.

Having found a lead compound, it was decided to try *simplifying* the structure to see

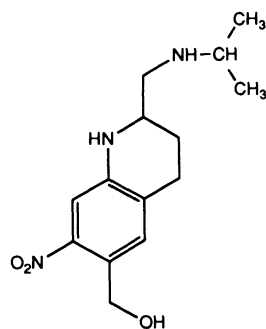

Fig. 7.31 Oxamniquine.

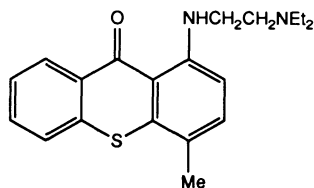

Fig. 7.32 Lucanthone.

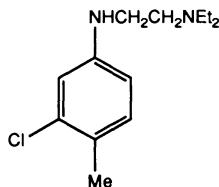

Fig. 7.33 Mirasan.

whether the tricyclic system was really necessary. Several compounds were made, and the most interesting structure was one where the two 'left-hand' rings had been removed.

This gave a compound called mirasan (Fig. 7.33) which retained the 'right-hand' aromatic ring containing the methyl and β -aminoethylamino side-chains *para* to each other. *Varying substituents* showed that an electronegative chloro substituent, positioned where the sulfur atom had been, was beneficial to activity. Mirasan was active against the bilharzia parasite in mice, but not in humans.

It was now reasoned that the β -aminoethylamino side-chain was important to receptor binding and would adopt a particular conformation in order to bind efficiently. This conformation would only be one of the many conformations which are available to a flexible molecule such as mirasan and so there would only be a limited chance of it being adopted at any one time.

Therefore, it was decided to try and restrict the number of possible conformations by incorporating the side-chain into a ring (*rigidification*). This would cut down the number of available conformations and increase the chance of the molecule having the correct conformation when it approached the receptor.

There was the risk, however, that the active conformation itself would be disallowed by this tactic. Therefore, rather than incorporate the whole side-chain into a ring structure, compounds were designed initially such that only portions of the chain were included.

The bicyclic structure (I) (Fig. 7.34) contains one of the side-chain bonds fixed in a ring to prevent rotation round that bond. It was found that this gave a dramatic improvement in activity. The compound was still not active in man, but unlike mirasan, it was active in monkeys. This gave hope that the chemists were on the right track. Further *rigidification* led to structure II (Fig. 7.34) where two of the side-chain bonds were constrained. This compound showed even more activity in mouse studies and it was decided to concentrate on this compound.

By now, it can be seen that the structure of the compound has been altered significantly from mirasan. In general, when a breakthrough has been achieved and a novel structure has been obtained, it is advisable to check whether past results still hold true. For example, does the chloro group still have to be ortho to the methyl? Can we change the chloro group for something else? Novel structures may fit the binding site slightly differently from the lead compound such that the binding groups

are no longer in the optimum positions for binding.

Therefore, structure II was modified by *varying substituents and substitution patterns* on the aromatic ring, and by *varying alkyl substituents* on the amino groups. Chains were also *extended* to search for other possible binding sites.

The results and possible conclusions were as follows.

- The substitution pattern on the aromatic ring could not be altered and was essential for activity. Altering the substitution pattern presumably places the essential binding groups out of position with respect to their binding sites.
- Replacing the chloro substituent with more electronegative substituents improved activity, with the nitro group being the best substituent. Therefore, an electron deficient aromatic ring is beneficial to activity. One possible explanation for this could be the effect of the neighbouring aromatic ring on the basicity of the nitrogen atom. A strongly electron deficient aromatic ring would 'pull' the cyclic nitrogen's lone pair of electrons into the ring, thus reducing its basicity (Fig. 7.35). This in turn might improve the pK_a of the drug such that it is less easily ionized and is able to pass through cell membranes more easily (see Chapter 8).

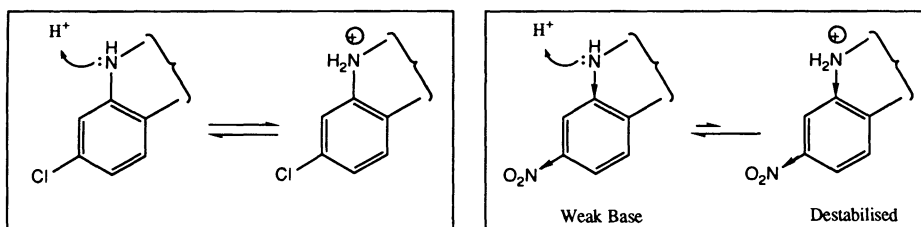

Fig. 7.35 Effect of aromatic substituents on pK_a .

- The best activities were found if the amino group on the side-chain was secondary rather than primary or tertiary (Fig. 7.36).

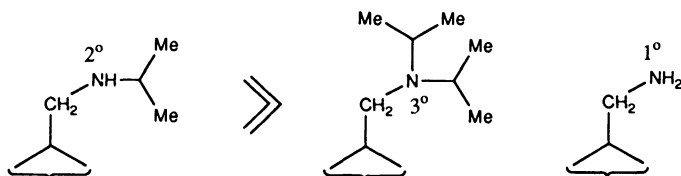

Fig. 7.36 Activity of secondary amino side chain.

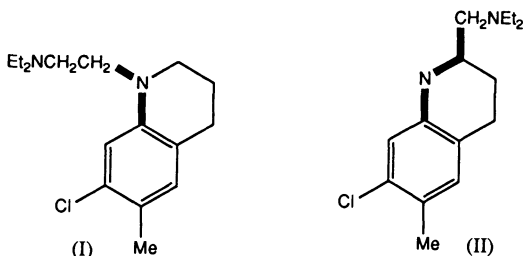

Fig. 7.34 Bicyclic structures I and II.

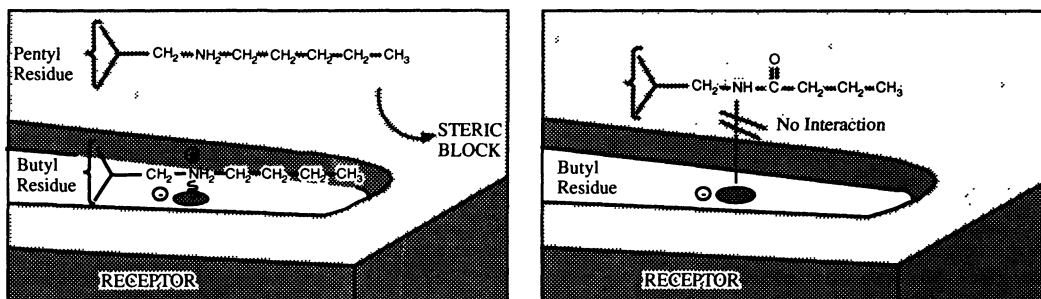

Fig. 7.37 Proposed ionic binding interaction.

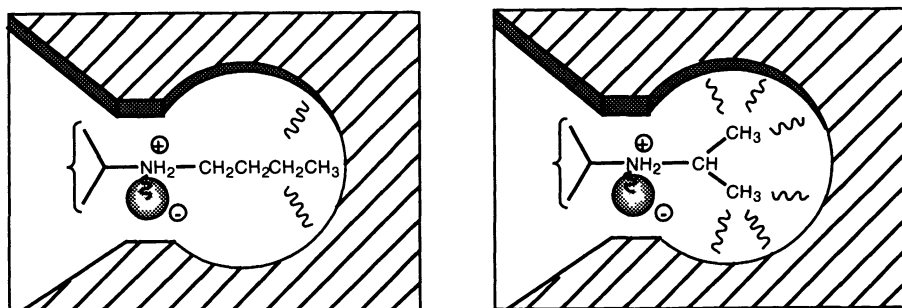

Fig. 7.38 Branching of the alkyl chain.

- The alkyl group on this nitrogen could be increased up to four carbon units with a corresponding increase in activity. Longer chains led to a reduction in activity. The latter result might imply that large substituents are too bulky and prevent the drug from binding to the binding site. Acyl groups eliminated activity altogether, emphasizing the importance of this nitrogen atom. Most likely, it is ionized and interacts with the receptor through an ionic bond (Fig. 7.37).
- Branching of the alkyl chain increased activity. A possible explanation could be that branching increases van der Waals interactions to a hydrophobic region of the binding site (Fig. 7.38). Alternatively, the lipophilicity of the drug might be increased, allowing easier passage through cell membranes.
- Putting a methyl group on the side-chain eliminated activity (Fig. 7.39). A methyl group is a bulky group compared with a proton and it is possible that it prevents the side-chain taking up the correct binding conformation.
- Extending the length of the side-chain by an extra methylene group eliminated activity (Fig. 7.40).

This tactic was tried in case the binding groups were not far enough apart for optimum binding. This result suggests the opposite.

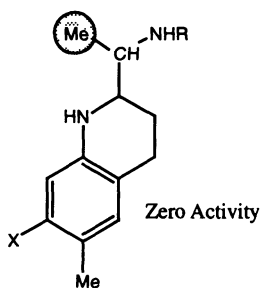

Fig. 7.39 Addition of a methyl group.

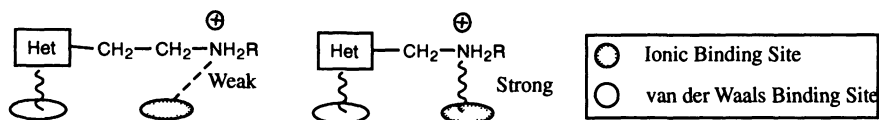

Fig. 7.40 Effect of extension of the side chain.

The optimum structure based on these results was structure III (Fig. 7.41). It has one chiral centre and, as one might expect, the activity was much greater in one enantiomer than it was in the other.

The tricyclic structure IV (Fig. 7.41) was also constructed. In this compound, the side-chain is fully incorporated into a ring structure, restricting the number of possible conformations drastically. As mentioned earlier, there was a risk that the active conformation

would no longer be allowed, but in this case good activity was still obtained. The same variations as above were carried out to show that a secondary amine was essential and that an electronegative group on the aromatic ring was required. However, some conflicting results were obtained compared with the previous results for structure III. A chloro substituent on the aromatic ring was better than a nitro, and it could be in either of the two possible *ortho* positions relative to the methyl group.

These results demonstrate that optimizing substituents in one structure does not necessarily mean that they will be optimum in a different skeleton.

One possible explanation for the chloro substituent being better than the nitro is that a less electronegative substituent is required to produce the optimum pK_a or basicity for membrane permeability.

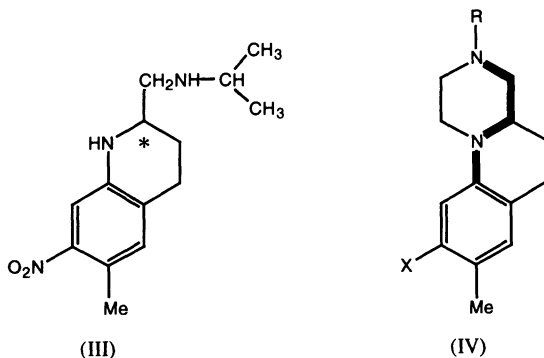

Fig. 7.41 The optimum structure (III) and the tricyclic structure (IV). *, Chiral centre.

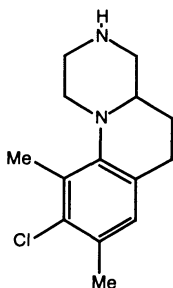

Fig. 7.42 Structure V.

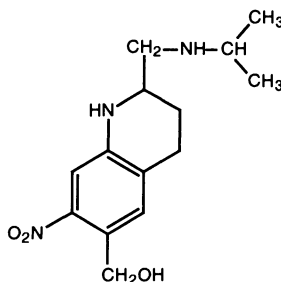

Fig. 7.43 Oxamniquine.

Adding a further methyl group on the aromatic ring to give the structure shown in Fig. 7.42 increased activity. It was proposed that the bulky methyl group was interacting with the piperazine ring and causing it to twist out of the plane of the other two rings. The increase in activity which resulted suggests that a better fitting conformation is obtained for the receptor.

This compound V (Fig. 7.42) was three times more active than structure III (Fig. 7.41). However, structure III was chosen for further development. The decision to choose III over V was based on preliminary toxicity results as well as the cost of producing the compounds. The cost of synthesizing III would be expected to be cheaper since it is a simpler molecule.

Further studies on the metabolism of related compounds then revealed that the methyl group on these compounds was oxidized in the body to a hydroxymethyl group and that this was in fact the active compound. The methyl group on III was replaced with a hydroxymethyl group to give oxamniquine (Fig. 7.43) which was

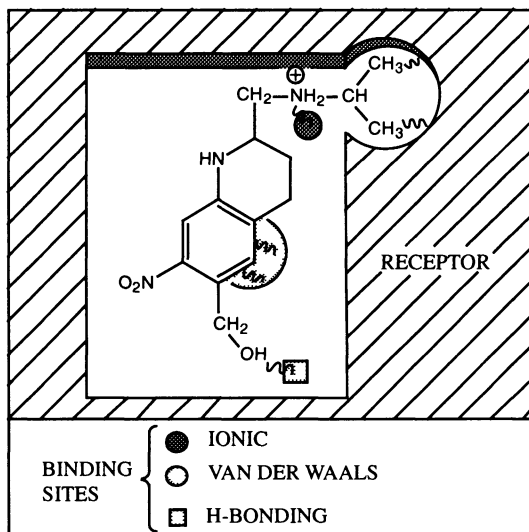

Fig. 7.44 Bonding interactions of oxamniquine.

found to be more active than the methyl structure (III). The drug was put on the market in 1975, eleven years after the start of the project.

It is now believed that compound III is totally inactive in itself. This is not as surprising as it may appear, since the metabolic reaction converts a non-polar methyl group to a polar hydroxymethyl group. Presumably the newly gained hydroxyl group forms an important hydrogen bond to the receptor (Fig. 7.44).

8 ■ Pharmacodynamics

8.1 *Drug distribution and 'survival'*

In Chapter 7, we concentrated on the interaction of drugs with binding sites. However, the compound which has the best binding interaction with its receptor is not necessarily the best drug to use in medicine. There are other variables which have to be taken into account.

The drug has to be stable enough to survive a rather tortuous journey through the body's circulatory system. It also has to be capable of negotiating barriers put in its way and not be diverted from its target.

For example, consider a drug taken as a pill. It has to dissolve in aqueous solution. It has to survive the acid of the stomach, then be absorbed from the gastrointestinal tract into the bloodstream. To do that it has to negotiate barriers in the form of cell membranes. It has to survive the destructive tendencies of the liver and its enzymes. It has to survive the enzymes present in the blood. If it is a lipophilic drug, it may be taken up by fat tissue. If it is anionic, it may get bound by plasma protein and if it is cationic, it may be bound by nucleic acids. It has to avoid being excreted by the kidneys or the bile duct. If the drug is aimed at the brain, it has to cross another cell barrier known as the blood–brain barrier. If it is to react with an enzyme, it has to negotiate another cell membrane to reach that.

Only then will the drug interact with its receptor or enzyme. As far as the drug is concerned, it is a long, strenuous, and dangerous journey.

Many of these problems can be avoided by giving the drug as an intravenous or intramuscular injection, but clearly orally administered drugs are preferred by the patient and if at all possible, drug design aims at an orally active compound. Let us look again at the journey which has to be followed by an orally administered drug.

The success of the journey depends principally on the physical properties of the drug. First of all, it has to be chemically stable and not break down in the acid conditions of the stomach. Secondly, it has to be metabolically stable so that it survives the hydrolytic enzymes present in the digestive system, liver, and blood-

stream. Thirdly, it has to have the correct balance of hydrophilic to hydrophobic character. Let us consider each of these factors in turn.

8.1.1 Chemical stability

There are several useful drugs with chemically labile functional groups. Penicillins have a chemically labile β -lactam ring which is susceptible to acid hydrolysis. Cholinergic agents have a susceptible ester group which is also susceptible to acid hydrolysis.

One way round the problem is to inject the drug in order to avoid the acid conditions of the stomach. However, there are strategies available which can be used to make the offending functional group less labile (see Section 8.3.2.).

8.1.2 Metabolic stability

Drugs are foreign substances¹ as far as the body is concerned and the body has its own method of getting rid of such chemical invaders. Non-specific enzymes (particularly in the liver) are able to add polar functional groups to a wide variety of drugs. Once the polar functional group has been added, the overall drug is more polar and water soluble, and is therefore more likely to be excreted when it passes through the kidneys.

An alternative set of non-specific enzymatic reactions can reveal 'masked' polar functional groups which might be present in a drug. For example, there are enzymes which can demethylate a methyl ether to reveal a more polar hydroxyl group. Once again, the more polar product (metabolite) is excreted more efficiently.

These reactions are classed as phase I reactions in the overall process of drug metabolism. They generally involve oxidation, reduction, and hydrolysis (Fig. 8.1).

The structures most prone to oxidation are *N*-methyl groups, aromatic rings, the terminal positions of alkyl chains, and the least hindered positions of alicyclic rings.

Nitro and carbonyl groups are prone to reduction by reductases, whilst amides and esters are prone to hydrolysis by esterases.

There is also a series of metabolic reactions classed as phase II reactions (Fig. 8.2). These are conjugation reactions whereby a polar molecule is attached to a suitable polar 'handle' which is either already present on the drug or has been placed there by a phase I reaction. The resulting conjugate has increased polarity, thus increasing its excretion rate in urine or bile even further.

Phenols, alcohols, and amines form *O*- or *N*-glucuronides by reaction with UDP-glucose such that the highly polar glucose molecule is attached to the drug.

Phenols, epoxides, and halides can react with the tripeptide glutathione to give mercapturic acids and some steroids can react with sulfates.

¹ Substances which are foreign to the particular biological system under study are known as xenobiotics. The word is derived from the Greek words 'xenos' meaning foreign and 'bios' meaning life.

OXIDATIONS (catalysed by cytochrome P-450)

Oxidation of 'Exposed' Alkyl Groups

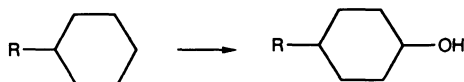
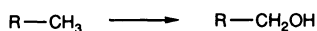

Oxidation of Alkenes and Aromatic Rings

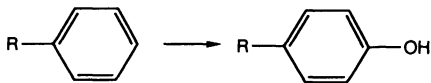
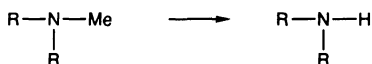
Oxidation of N-Alkyl Groups (Dealkylation)

REDUCTIONS

Reductions of Nitro and Azo Groups

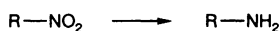

HYDROLYSES

Hydrolysis of Esters and Amides

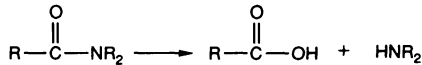
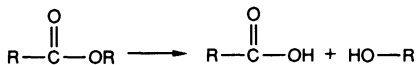

Fig. 8.1 Drug metabolism: phase I reactions.

8.1.3 Hydrophilic/hydrophobic balance

In order to cross hydrophobic cell membranes, a drug has to be reasonably lipophilic (fat loving). However, it cannot be too lipophilic. If it is, then it would very swiftly be extracted from an aqueous bloodstream and be stored away in the fatty tissues of the body. This fat solubility can lead to problems. For example, obese patients undergoing surgery require a larger than normal volume of anaesthetic since the gases used are particularly fat soluble. Unfortunately, once surgery is over and the patient has regained consciousness, the anaesthetics stored in the fat tissues will be released and may render the patient unconscious again.

Barbiturates such as thiopental were once seen as potential intravenous anaesthetics which could replace the anaesthetic gases. Unfortunately, they too are fat soluble and as a result it is extremely difficult to estimate a sustained safe dosage. The initial dose can be estimated safely enough to allow for barbiturate taken up by fat cells (and thus removed from the system). However, further doses eventually lead to saturation of the fat depot, and result in a sudden and perhaps fatal increase of barbiturate levels in the blood supply.

GLUCURONIDES

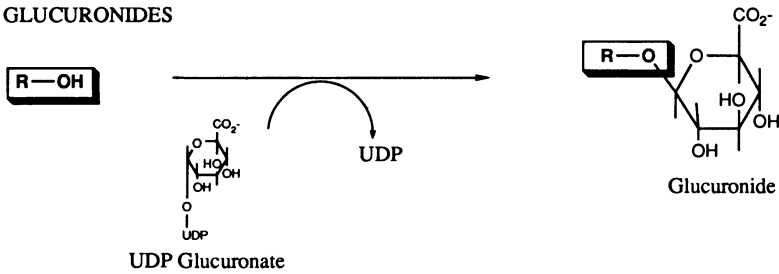

SULPHATES

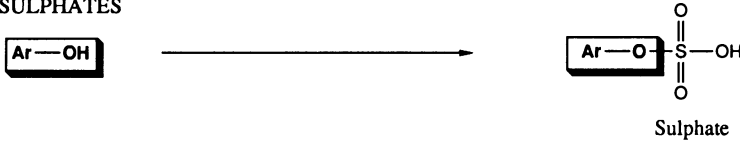

GLUTATHIONE CONJUGATES

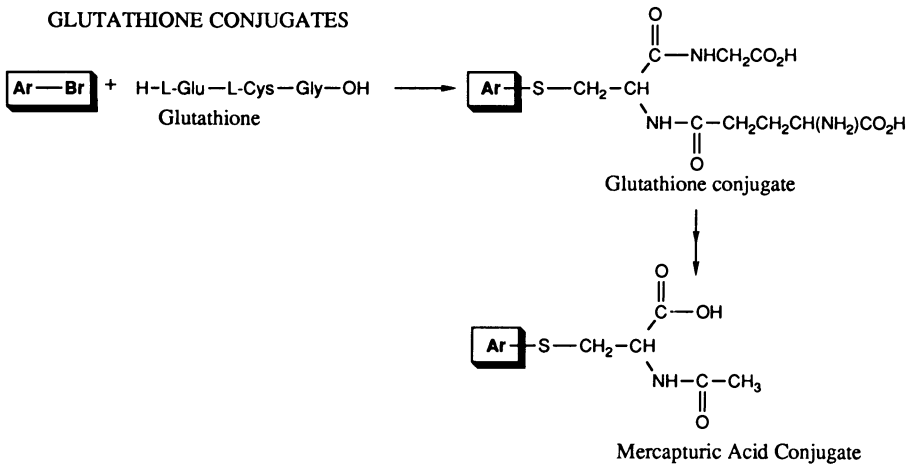

Fig. 8.2 Drug metabolism: phase II reactions (conjugation).

In general, fat-soluble drugs tend to get locked away in fat depots and consequently do not reach the target protein very efficiently.

If fat solubility is a problem, why not design drugs to be as hydrophilic as possible? After all, most drugs will need polar or ionic groups in order to bind to their receptor or enzyme.

Yet, how would such a molecule cross the fatty barriers of cell membranes?

We have here an apparent contradiction. The drugs which bind most strongly to the receptor are often very polar, ionized compounds, but have no chance of crossing the fatty cell membranes of the intestinal wall. On the other hand, the drugs which

can easily negotiate the fatty cell membranes get mopped up by fat tissue or are too weak to bind to their receptor sites.

Consequently, the best drugs are usually a compromise. They are neither too lipophilic nor too hydrophilic. In general, it is found that the most effective drugs have a pK_a value in the range 6–8. In other words, they are drugs which are partially ionized at blood pH and can easily equilibrate between their ionized and non-ionized forms. This allows them to cross cell membranes in the non-ionized form and to bind to their receptor in the ionized form (Fig. 8.3).

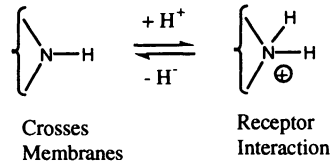

Fig. 8.3 Hydrophobic/hydrophilic balance.

On the other hand, it is sometimes useful to have a fully ionized drug which is incapable of crossing cell membranes. For example, highly ionized sulfonamides are used against gastrointestinal infections. They are incapable of crossing the gut wall and are therefore directed efficiently against the infection.

8.2 Drug dose levels

Estimating dose levels for certain drugs can be a problem with a further range of variables to be taken into account.

Ideally, the blood levels of any drug should be constant and controlled, but this would require a continuous, intravenous drip which is clearly impractical. Therefore, most drugs are taken at regular time intervals and the doses taken are designed to keep the blood levels of drug within a maximum and minimum level such that they are not too high to be toxic, yet not too low to be ineffective. This works well in most cases, but there are certain situations where it does not. The treatment of diabetes with insulin is a case in point. Insulin is normally secreted continuously by the pancreas and so the injection of insulin at timed intervals is unnatural and can lead to a whole range of physiological complications.

Other complications include differences of age, sex, and race. Diet, environment, and altitude also have an influence. Body weight is an important factor to be taken into account. Obese people present a particular problem since it can prove very difficult to estimate how much of a drug will be stored in fat tissue and how much will be free drug. The precise time when drugs are taken may be important since metabolic reaction rates can vary throughout the day.

Drugs can interact with other drugs. For example, some drugs used for diabetes are bound by plasma protein in the blood supply and are therefore not 'free' to react with receptors. However, they can be displaced from the plasma protein by aspirin and this can lead to a drug overdose. A similar phenomenon is observed between anticoagulants and aspirin.

Problems can also occur if a drug taken to inhibit a metabolic reaction is taken with a drug normally metabolized by that reaction. The latter would then be more slowly metabolized, increasing the risk of an overdose. For example, the antidepressant drug phenelzine (Fig. 8.4) inhibits the metabolism of amines and should not be taken with drugs such as amphetamines or pethidine. Even amine-rich foods can lead to adverse effects, implying that cheese and wine parties are hardly the way to cheer the victim of depression.

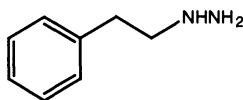

Fig. 8.4 Phenelzine.

When one considers all these complications, it is hardly surprising that individual variability to drugs can vary by as much as a factor of ten.

8.3 Drug design for pharmacokinetic problems

Drug design aimed at solving any or all of the above problems can involve a lot of trial and error, basically because of the many variables involved. However, there are some strategies which can be usefully employed.

8.3.1 Variation of substituents

Easily accessible substituents can often be varied to improve the pK_a and lipophilic properties of a compound (Chapter 7). Such studies are particularly open to a quantitative approach known as the quantitative structure–activity relationship (QSAR) approach, discussed in Chapter 9.

8.3.2 Stereoelectronic modifications

The development of the local anaesthetic lidocaine from procaine (Fig. 8.5) is a good example of how the use of steric and electronic effects can make a drug more stable, both chemically and metabolically. Procaine is a good local anaesthetic, but it is short-lasting due to the hydrolysis of the ester group. By changing the ester group to the less reactive amide group, chemical hydrolysis is reduced.

Furthermore, the presence of two *ortho*-methyl groups on the aromatic ring help to shield the carbonyl group from attack by enzymes.

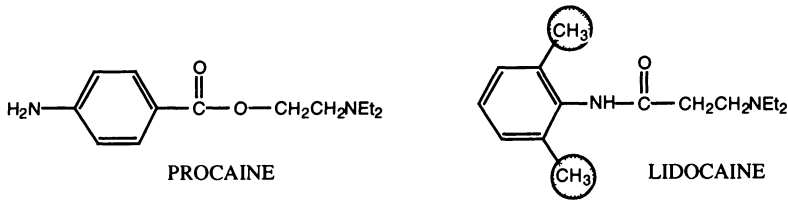

Fig. 8.5

A further example of these tactics is provided in the penicillin field with methicillin (Chapter 10).

8.3.3 Metabolic blockers

Some drugs are metabolized at particular positions in their skeleton. For example, the oral contraceptive megestrol acetate is oxidized at position 6 to give a hydroxyl group at that position. The introduction of a polar group such as this usually allows the formation of polar conjugates which can be quickly eliminated from the system.

The introduction of a stable group such as a methyl group at position 6 (Fig 8.6) can block metabolism and so prolong the activity of the drug.

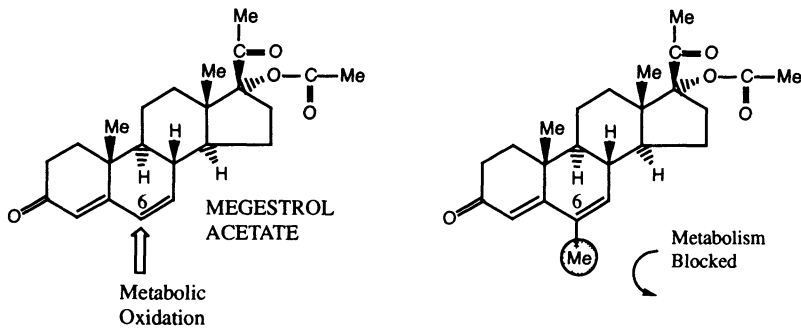

Fig. 8.6 Metabolic blockers.

8.3.4 Removal of susceptible metabolic groups

There are certain chemical groups which are particularly susceptible to metabolic enzymes. For example, methyl groups on aromatic rings can be oxidized to carboxylic acids (Fig. 8.7). These acids can then be quickly eliminated from the body.

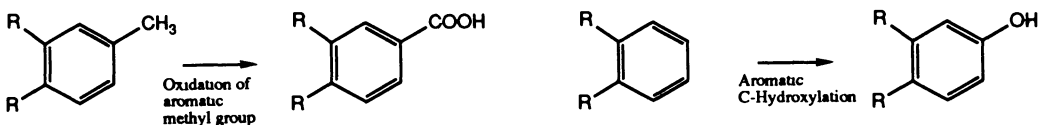

Fig. 8.7 Examples of chemical groups susceptible to metabolic enzymes.

Other common metabolic reactions include aliphatic and aromatic C-hydroxylations (Fig. 8.7), N- and S-oxidations, O- and S-dealkylations, and deamination.

Susceptible groups can sometimes be replaced with groups that are stable to oxidation in order to prolong the lifetime of the drug. For example, the methyl group of the antidiabetic tolbutamide was replaced with a chlorine atom to give chlorpropamide which is much longer lasting (Fig. 8.8).

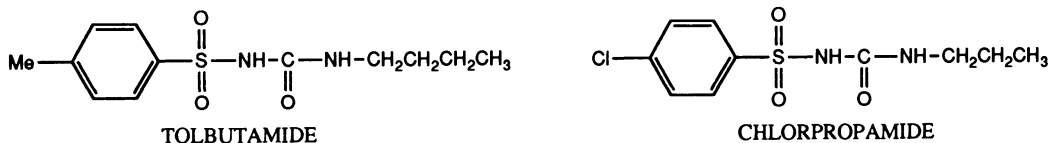

Fig. 8.8

But suppose the vulnerable group is also crucial for activity? If we cannot replace it or remove it, what can we do?

There are two possible solutions. We can either mask the vulnerable group on a temporary basis by using a prodrug (see later) or we can try 'shifting' the vulnerable group away from whatever is making it vulnerable. The latter tactic was used in the development of salbutamol (Fig. 8.9). Salbutamol is a highly successful drug which was introduced in 1969 for the treatment of asthma. It is an analogue of the neurotransmitter noradrenaline (Fig. 8.9)—a catechol structure containing two *o*-phenolic groups

One of the problems faced by catechol compounds, such as noradrenaline, is the metabolic methylation of one of the phenolic groups. Since both phenol groups are involved in hydrogen bonds to the receptor, the masking of one of the phenol groups disrupts the hydrogen bonding and makes the compound inactive.

The noradrenaline analogue (I) shown in Fig. 8.10 has useful antiasthmatic activity, but it is of short duration due to its rapid metabolism to the inactive methyl ether (II).

Replacing the OH with something like a proton or a methyl group may prevent the metabolism but will also prevent the important hydrogen bonding. So how was the problem solved?

The answer was to move the vulnerable OH group out from the ring by one carbon unit. This was enough to make the compound unrecognizable to the metabolic enzyme.

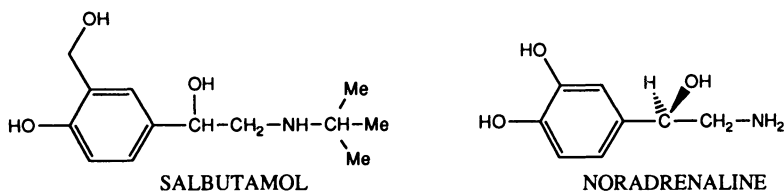

Fig. 8.9

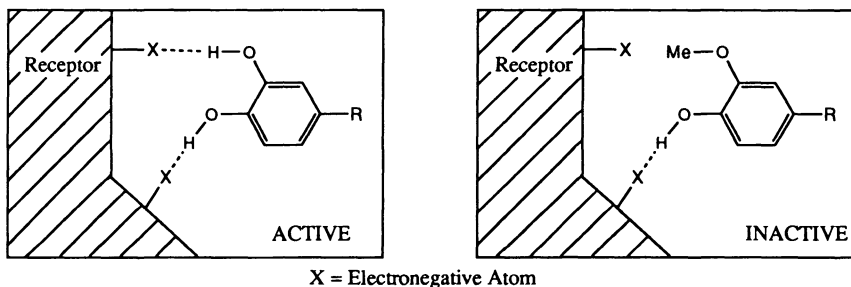
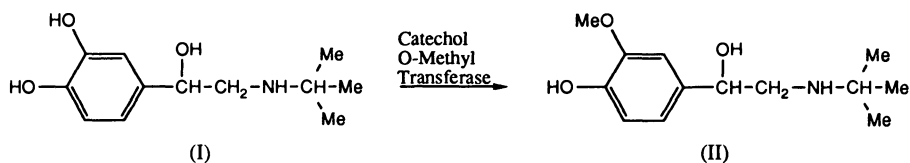

Fig. 8.10 Metabolic methylation of a noradrenaline analogue.

Fortunately, the receptor appears to be quite lenient over the position of this hydrogen bonding group and it is interesting to note that a hydroxyethyl group is also acceptable. Beyond that, activity is lost due to the OH being 'out of range' or being too large to fit. These results demonstrate that it is better to consider a receptor binding site as an available volume rather than imagining the binding site as fixed at one spot. A drug can then be designed such that the relevant binding group is positioned into any part of that available volume (Fig. 8.11).

The tactic worked, but there was no way of knowing beforehand whether the receptor itself would still recognize the structure. Several factors could well have prevented the necessary hydrogen bonding interaction. The CH_2OH group might have been too bulky to fit. The group may have been too far from the binding site. The fact that an acidic phenol had been replaced with a neutral alcohol group could have destroyed the bonding interaction.

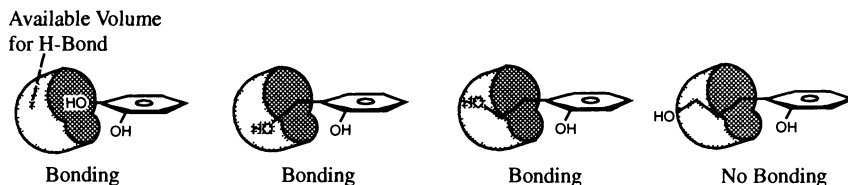

Fig. 8.11 Receptor binding site as an available volume.

8.3.5 Prodrugs

Prodrugs are compounds which may be inactive in themselves, but which can be converted by chemical or enzymatic means to an active drug. They have been useful

in tackling problems such as acid sensitivity, poor membrane permeability, drug toxicity, and short duration of action.

Prodrugs to improve membrane permeability

Prodrugs have proved very useful in temporarily masking an 'awkward' functional group which is important to receptor binding, but which hinders the drug from crossing cell membranes. For example, a carboxylic acid functional group may have an important role to play in binding the drug to a receptor via ionic or hydrogen bonding. However, the very fact that it is an ionizable group may prevent it from crossing a fatty cell membrane. The answer is to protect the acid function as an ester. The less polar ester can cross fatty cell membranes and once in the bloodstream, it will be hydrolysed back to the free acid by esterases in the blood. An example of such a prodrug is the antibacterial agent pivampicillin—a prodrug for ampicillin (Chapter 10).

N-Demethylation is a common metabolic reaction in the liver. Therefore, primary or secondary amines could be N-methylated to improve their membrane permeability. Several hypnotics and antiepileptics take advantage of this reaction (e.g. hexobarbitone (Fig. 8.12)).

Another way round the problem of membrane permeability is to design a prodrug which can take advantage of a carrier protein in the cell membrane, such as the one responsible for carrying amino acids into a cell. The best known example of such a prodrug is levodopa (Fig. 8.13).

Levodopa is a prodrug for the neurotransmitter dopamine and as such has been used in the treatment of Parkinson's disease—a condition due primarily to a deficiency of the neurotransmitter dopamine. Dopamine itself cannot be used since it is too polar to cross the blood-brain barrier. Levodopa is even more polar and seems an unlikely prodrug. However, it is an amino acid and as such can make use of the special 'arrangements' made in order to move amino acids across the blood-brain barrier. Amino acids are essential building blocks for all cells, but are incapable of crossing hydrophobic membranes by themselves. There is, however, a process by which amino acids can be shuttled through membranes such as the blood-brain barrier. This

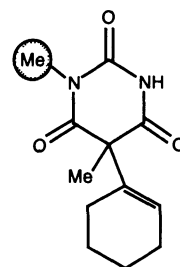
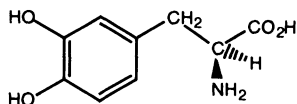
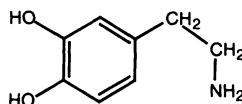

Fig. 8.12 Hexobarbitone.



LEVODOPA



DOPAMINE

Fig. 8.13

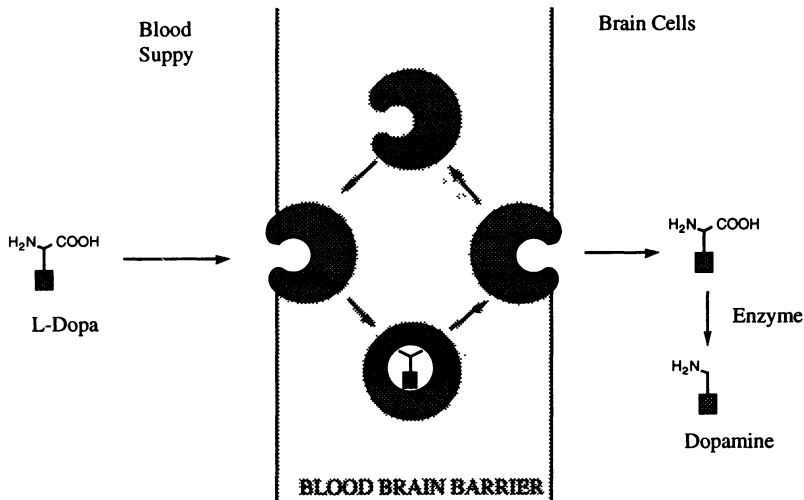

Fig. 8.14 Transport of levodopa across the blood-brain barrier.

involves a protein carrier system which is embedded in the membrane and 'smuggles' its passengers from one side to the other (Chapter 5). Once across the barrier, a decarboxylase enzyme removes the acid group and generates dopamine (Fig. 8.14).

Another means of taking advantage of the transport proteins is to attach the active drug to an amino acid or nucleic acid base such that the drug gets a 'piggyback' across the membrane. Uracil mustard (Fig. 8.23) is one such example.

Prodrugs for prolonged activity

6-Mercaptopurine (Fig. 8.15) suppresses the body's immune response and is therefore useful in protecting donor grafts. However, the drug tends to be eliminated from the body too quickly. The prodrug azathioprine (Fig 8.15) lasts far longer. Azathioprine is slowly converted to 6-mercaptopurine, allowing a more sustained activity. Since the conversion is chemical and unaffected by enzymes, the rate of conversion can be altered, depending on the electron withdrawing ability of the heterocyclic group. The greater the electron withdrawing power, the faster the breakdown. The NO_2 group is therefore present to ensure an efficient conversion to 6-mercaptopurine, since it is strongly electron withdrawing.

There is a belief that the well-known sedatives Valium (Fig. 8.16) and Librium might be prodrugs and are only active because they are metabolized by *N*-demethylation to nordazepam. Nordazepam itself has been used as a sedative, but loses activity quite quickly due to metabolism and excretion. Valium, if it is a prodrug for nordazepam, demonstrates again how a prodrug can be used to lead to a more sustained action.

One approach to maintaining a sustained level of drug over long periods is to

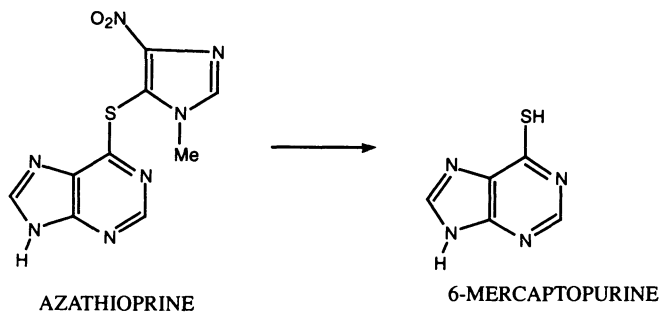

Fig. 8.15 Azathioprine acts as a prodrug for 6-mercaptopurine.

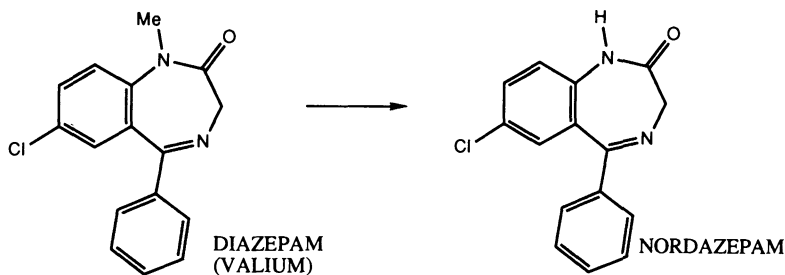

Fig. 8.16 Valium as a possible prodrug for nordazepam.

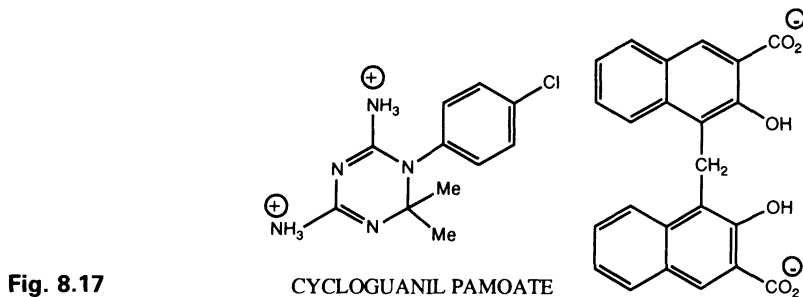

Fig. 8.17

deliberately associate a very lipophilic group with an active drug. This means that the majority of the drug is stored in fat tissue, and if the lipophilic group is only slowly removed, then the drug is steadily released into the bloodstream over a long period of time. The antimalarial agent cycloguanil pamoate (Fig. 8.17) is one such agent. The active drug is bound ionically to an anion with a large lipophilic group.

Prodrugs masking drug toxicity and side-effects

Prodrugs can be used to mask the side-effects and toxicity of drugs. For example, salicylic acid is a good painkiller, but causes gastric bleeding due to the free phenolic group. This is overcome by masking the phenol as an ester (aspirin) (Fig. 8.18). The ester is later hydrolysed by esterases to free the active drug.

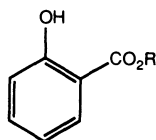

Fig. 8.18

SALICYLIC ACID R = H
 ASPIRIN R = Ac

Prodrugs can be used to give a slow release of drugs which would be too toxic to give directly. Propiotaldehyde is useful in the aversion therapy of alcohol, but is not used itself since it is an irritant. However, the prodrug pargylene can be converted to propiotaldehyde by enzymes in the liver (Fig. 8.19).

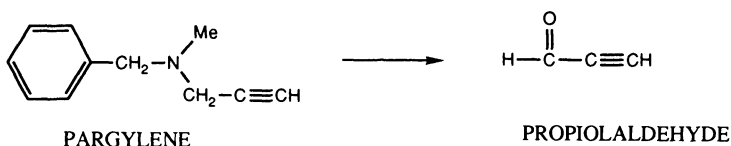

Fig. 8.19 Pargylene as a prodrug for propiotaldehyde.

An extension of this tactic is to design a prodrug such that it is converted to the active drug at the target site itself. If this can be achieved successfully, it will greatly reduce the side-effects of highly toxic drugs such as the anticancer agents. Cyclophosphamide is a successful anticancer drug which is not toxic itself, but which is converted in several steps to the toxic phosphoramidate mustard (Fig. 8.20). This is a strong alkylating agent which will alkylate a cell's DNA and thus kill the cell. Since there is a high level of phosphoramidase enzyme in some tumour cells, it was hoped that the drug could be directed selectively against these cells. Some selectivity has indeed been observed and it is hoped that complete selectivity can eventually be achieved.

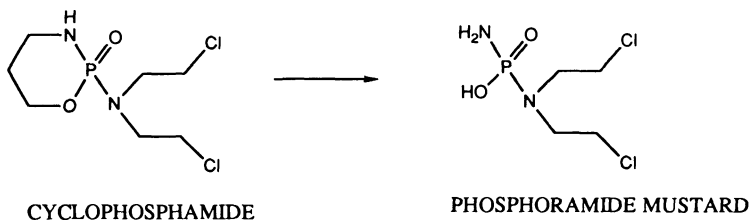

Fig. 8.20

8.3.6 Bioisosteres

A bioisostere is a chemical group which can replace another chemical group without affecting biological activity.

Many peptides and polypeptides are chemical messengers in the body, yet using such compounds as medicines is impractical since the body's own digestive enzymes can hydrolyse the peptide links. One answer to the problem has been to replace the peptide bond with another functional group which is stable to these hydrolytic enzymes. For example, a peptide bond might be replaced with a double bond. If the compound retains activity, then the double bond represents a bioisostere for the peptide link *in this particular case*. Note that bioisosteres are not general. They are specific for the drug and the protein with which it interacts. A successful bioisostere in one field of medicinal chemistry may be useless in a different field. Note also that bioisosteres are different from isosteres. It is the retention of important biological activity which determines whether a group is a bioisostere, not the valency.

An example of how bioisosteric groups have been used successfully is provided by the cholinergic drug bethanechol described in Chapter 11.

8.3.7 'Sentry' drugs—synergism

In this approach, a second drug is administered along with the drug which is 'going into action'. The role of the second drug is to guard or assist the principal drug. Usually, the second drug is an antagonist of an enzyme which metabolizes the principal drug.

For example, clavulanic acid inhibits the enzyme β -lactamase and is therefore able to protect penicillins which are labile to that particular enzyme (Chapter 10).

Another example is to be found in the drug therapy of Parkinson's disease. The use of L-dopa (levodopa) as a prodrug for dopamine has already been described. However, to be effective, large doses of L-dopa (3–8 g per day) are required, and over a period of time these dose levels lead to side-effects such as nausea and vomiting. L-Dopa is susceptible to the enzyme dopa decarboxylase and as a result, much of the L-dopa administered is decarboxylated to L-dopamine before it reaches the central nervous system (Fig. 8.21).

As stated earlier, dopamine is unable to cross the blood–brain barrier. As a result, an excess of dopamine builds up in the peripheral blood supply and this is what leads to the nausea and vomiting side-effects.

If an antagonist was administered to dopa decarboxylase, then it would inhibit the decarboxylation of L-dopa and less would be required. The drug carbidopa has been

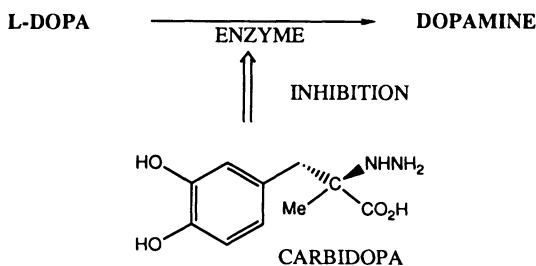

Fig. 8.21 Inhibition of L-dopa decarboxylation.

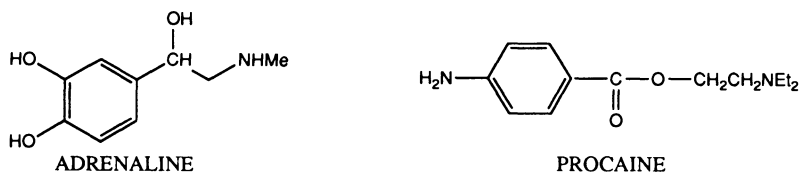

Fig. 8.22

used successfully in this respect and effectively inhibits dopa decarboxylase. Furthermore, since it is a highly polar compound containing two phenolic groups, a hydrazine moiety, and an acidic group, it is unable to cross the blood–brain barrier and so cannot prevent the conversion of L-dopa to dopamine in the brain.

Adrenaline is an example of a ‘sentry drug’ which acts on a receptor rather than an enzyme. This drug is used along with the injectable local anaesthetic procaine to prolong its action (Fig. 8.22). Adrenaline constricts the blood vessels in the vicinity of the injection and so prevents procaine being ‘washed away’ by the blood supply.

8.3.8 ‘Search and destroy’ drugs

A major goal in cancer chemotherapy is to target drugs efficiently against tumour cells rather than normal cells. One method of achieving this is to design a drug transport system. The idea is to attach the active drug to a molecule which is needed in large amounts by the rapidly dividing tumour cells. One approach has been to attach the active drug to an amino acid or a nucleic acid base, e.g. uracil mustard (Fig. 8.23).

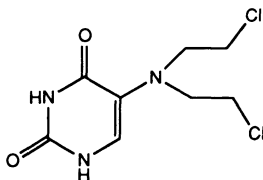

Fig. 8.23 Uracil mustard.

Of course, normal cells require these building blocks as well, but tumour cells often grow more quickly than normal cells and require the building blocks more urgently. Therefore, the uptake of these drugs should be greater in tumour cells than in normal cells. This approach has the added advantage that the drug can enter the cell more efficiently by using the transport proteins for the particular building block.

The tactic has been reasonably successful, but has not yet lived up to expectation.

A more recent idea has been to attach the active drug to monoclonal antibodies which can recognize antigens unique to the tumour cell. The difficulty is in finding suitable antigens and producing the antibodies in significant quantity. However, the approach has great promise for the future.

8.3.9 Self-destruct drugs

Occasionally, the problems faced are completely the opposite of those mentioned above. A drug which is extremely stable to metabolism and very slowly excreted can pose just as many problems as one with the opposite properties. It is usually desirable to have a drug which performs what it is meant to do, then stops doing it within a reasonable time. If not, the effects of the drug could last far too long and cause toxicity and lingering side-effects. Therefore, designing drugs with decreased chemical and metabolic stability can be useful on occasions.

The neuromuscular drug atracurium (Chapter 11) is a good example of this.

8.3.10 Delivery systems

Continuous minipumps have been developed which can release insulin at varying rates depending on blood-glucose levels. This appears to be the best answer to the problem of providing insulin at the correct levels at the correct times.

Some acid-sensitive drugs can be protected by the way they are formulated. For example, it is possible to coat pills with an acid-resistant polymer which protects the drug from the acids in the stomach. The polymer is designed to be removed under the slightly alkaline conditions of the large intestine. Unfortunately, absorption in the large intestine is not so efficient as the small intestine and so the applications are limited.

A physical way of protecting drugs from metabolic enzymes in the bloodstream is to inject small vesicles called liposomes filled with the drug. These vesicles or globules consist of a bilayer of fatty molecules in the same way as a cell membrane and will travel round the circulation, slowly leaking their contents.

8.4 Testing of drugs

It is unlikely that the thorny problem of animal testing will disappear for a long time. As can be seen already, there are so many variables involved in determining whether a drug will be effective or not that it is impossible to anticipate them all. One has also to take into account that the drug will be metabolized to other compounds, all with their own range of biological properties.

It appears impossible, therefore, to predict whether a potential drug will work or whether it will be safe by *in vitro* tests alone. Therein lies the importance of animal experiments. Only animal tests can test for the unexpected. Unless we are prepared to volunteer ourselves as guinea pigs, then animal experiments will remain an essential feature of drug development for many years to come. A more realistic ambition for the near future is to reduce the number of animal tests by developing more *in vitro* tests. For example, the metabolism of drugs is being studied initially by using liver cells

grown in culture. If these tests are satisfactory, then animal studies can follow on. If the tests are unsatisfactory, then the animals are spared.

8.5 Neurotransmitters as drugs?

Before finishing this chapter, let us consider the body's own neurotransmitters. Why do we not use these as drugs? If the body is short of dopamine, why not administer more dopamine to make up the balance? After all, most neurotransmitters which have been identified are simple molecules, easily prepared in the laboratory.

Unfortunately, this is not possible for a number of reasons. Many are not chemically stable enough to survive the acid of the stomach and would have to be injected. Even if they were injected, there is little chance that they would survive to reach their target receptors. As mentioned already, the body has efficient mechanisms by which it inactivates its neurotransmitters as soon as they have passed on their message. Therefore, on injection, they would be swiftly inactivated by enzymes or by cell uptake.

Even if they were to survive, they could lead to undesirable side-effects. For example, the shortage of neurotransmitter may only be at one small area in the brain and be normal elsewhere. If we gave the natural neurotransmitter, how would we stop it producing an overdose of transmitter at these other sites? This of course is a problem with all drugs, but in recent years it has been discovered that receptors for a specific neurotransmitter are slightly different, depending on where they are in the body. The medicinal chemist can design synthetic drugs which take advantage of that difference, such that they 'ignore' receptors which the natural neurotransmitter would not. In this respect, the medicinal chemist has actually improved on nature.

We cannot even assume that the body's own neurotransmitters are perfectly safe and free from the horrors of tolerance and addiction associated with drugs such as heroin. It is quite possible to be addicted to one's own neurotransmitters and hormones. Some people are addicted to exercise and are compelled to exercise long hours each day in order to feel good. The very process of exercise leads to the release of hormones and neurotransmitters. This can produce a 'high', which drives susceptible people to exercise more and more. If they stop exercising, they suffer withdrawal symptoms such as deep depression.

The same phenomenon probably drives mountaineers into attempting feats which they know quite well may lead to their death. The thrill of danger produces hormones and neurotransmitters which in turn produce a 'high'. Perhaps this too is why war has such a fascination for mankind.

To conclude, many of the body's own neurotransmitters are known and can be easily synthesized, but they cannot be effectively used as medicines.

9 ■ Quantitative structure–activity relationships (QSAR)

9.1 *Introduction*

In Chapters 7 and 8 we studied the various strategies which can be used in the design of drugs. Several of these strategies involved a change in shape such that the new drug had a better ‘fit’ for its receptor. Other strategies involved a change in the physical properties of the drug such that its distribution, metabolism, or receptor binding interactions were affected. These latter strategies often involved the synthesis of analogues containing a range of substituents on aromatic/heteroaromatic rings or accessible functional groups. There are an infinite number of possible analogues which can be made, if we were to try and synthesize analogues with every substituent and combination of substituents possible. Therefore, it is clearly advantageous if a rational approach can be followed in deciding which substituents to use. The QSAR (quantitative structure–activity relationship) approach has proved extremely useful in tackling this problem.

The QSAR approach attempts to identify and quantify the physicochemical properties of a drug and to see whether any of these properties has an effect on the drug’s biological activity. If such a relationship holds true, an equation can be drawn up which quantifies the relationship and allows the medicinal chemist to say with some confidence that the property (or properties) has an important role in the distribution or mechanism of the drug. It also allows the medicinal chemist some level of prediction. By quantifying physicochemical properties, it should be possible to calculate in advance what the biological activity of a novel analogue might be. There are two advantages to this. Firstly, it allows the medicinal chemist to target efforts on analogues which should have improved activity and thus cut down the number of analogues which have to be made. Secondly, if an analogue is discovered which does not fit the equation, it implies that some other feature is important and provides a lead for further development.

What are these physicochemical features which we have mentioned?

Essentially, they refer to any structural, physical, or chemical property of a drug. Clearly, any drug will have a large number of such properties and it would be a Herculean task to quantify and relate them all to biological activity at the same time. A simple, more practical approach is to consider one or two physicochemical properties of the drug and to vary these while attempting to keep other properties constant. This is not as simple as it sounds, since it is not always possible to vary one property without affecting another. Nevertheless, there have been numerous examples where the approach has worked.

9.2 Graphs and equations

In the simplest situation, a range of compounds are synthesized in order to vary one physicochemical property (e.g. $\log P$) and to test how this affects the biological activity ($\log 1/C$) (we will come to the meaning of $\log 1/C$ and $\log P$ in due course). A graph is then drawn to plot the biological activity on the y axis versus the physicochemical feature on the x axis (Fig. 9.1).

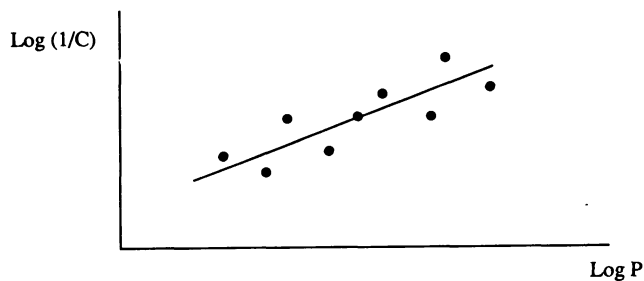

Fig. 9.1 Biological activity versus physicochemical property.

It is then necessary to draw the best possible line through the data points on the graph. This is done by a procedure known as 'linear regression analysis by the least squares method'. This is quite a mouthful and can produce a glazed expression on any chemist who is not mathematically orientated. In fact, the principle is quite straightforward.

If we draw a line through a set of data points, most of the points will be scattered on either side of the line. The best line will be the one closest to the data points. To measure how close the data points are, vertical lines are drawn from each point (Fig. 9.2). These verticals are measured and then squared in order to eliminate the negative values. The squares are then added up to give a total. The best line through the points will be the line where this total is a minimum.

The equation of the straight line will be $y = k_1x + k_2$ where k_1 and k_2 are constants. By varying k_1 and k_2 , different equations are obtained until the best line is obtained. This whole process can be speedily done by computer programme.

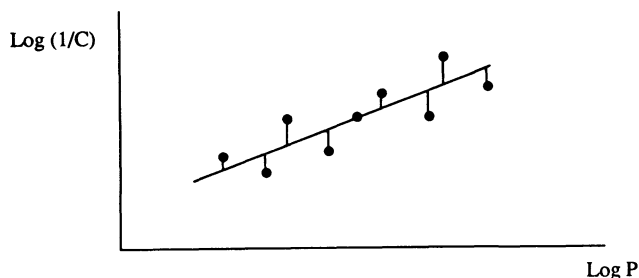

Fig. 9.2 Proximity of data points to line of best fit.

The next stage in the process is to see whether the relationship is significant. We may have obtained a straight line through points which are so random that it means nothing. The significance of the equation is given by a term known as the regression coefficient (r). This coefficient can again be calculated by computer. For a perfect fit, $r^2 = 1$. Good fits generally have r^2 values of 0.95 or above.

9.3 Physicochemical properties

There are many physical, structural, and chemical properties which have been studied by the QSAR approach, but the most commonly studied are hydrophobic, electronic, and steric. This is because it is possible to quantify these effects relatively easily.

In particular, hydrophobic properties can be easily quantified for complete molecules or for individual substituents. On the other hand, electronic and steric properties are more difficult to quantify, and quantification is only really feasible for individual substituents.

Consequently, QSAR studies on a variety of totally different structures are relatively rare and are limited to studies on hydrophobicity. It is more common to find QSAR studies being carried out on compounds of the same general structure, where substituents on aromatic rings or accessible functional groups are varied. The QSAR study then considers how the hydrophobic, electronic, and steric properties of the substituents affect biological activity.

The three most studied physicochemical properties will now be considered in some detail.

9.3.1 Hydrophobicity

The hydrophobic character of a drug is crucial to how easily it crosses cell membranes (see Section 8.1.3.) and may also be important in receptor interactions. Changing substituents on a drug may well have significant effects on its hydrophobic character and hence its biological activity. Therefore, it is important to have a means of predicting this quantitatively.

The partition coefficient (P)

The hydrophobic character of a drug can be measured experimentally by testing the drug's relative distribution in an octanol/water mixture. Hydrophobic molecules will prefer to dissolve in the octanol layer of this two-phase system, whereas hydrophilic molecules will prefer the aqueous layer. The relative distribution is known as the partition coefficient (P) and is obtained from the following equation:

$$P = \frac{\text{Concentration of drug in octanol}}{\text{Concentration of drug in aqueous solution}}$$

Hydrophobic compounds will have a high P value, whereas hydrophilic compounds will have a low P value.

Varying substituents on the lead compound will produce a series of analogues having different hydrophobicities and therefore different P values. By plotting these P values against the biological activity of these drugs, it is possible to see if there is any relationship between the two properties. The biological activity is normally expressed as $1/C$, where C is the concentration of drug required to achieve a defined level of biological activity. (The reciprocal of the concentration ($1/C$) is used, since more active drugs will achieve a defined biological activity at lower concentration.)

The graph is drawn by plotting $\log(1/C)$ versus $\log P$. The scale of numbers involved in measuring C and P usually covers several factors of ten and so the use of logarithms allows the use of more manageable numbers.

In studies where the range of the $\log P$ values is restricted to a small range (e.g. $\log P = 1-4$), a straight-line graph is obtained (Fig. 9.1) showing that there is a relationship between hydrophobicity and biological activity. Such a line would have the following equation:

$$\log\left(\frac{1}{C}\right) = k_1 \log P + k_2.$$

For example, the binding of drugs to serum albumin is determined by their hydrophobicity and a study of 40 compounds resulted in the following equation:

$$\log\left(\frac{1}{C}\right) = 0.75 \log P + 2.30.$$

The equation shows that serum albumin binding increases as $\log P$ increases. In other words, hydrophobic drugs bind more strongly to serum albumin than hydrophilic drugs. Knowing how strongly a drug binds to serum albumin can be important in estimating effective dose levels for that drug. When bound to serum albumin, the drug cannot bind to its receptor and so the dose levels for the drug should be based on the amount of unbound drug present in the circulation. The equation above allows us

to calculate how strongly drugs of similar structure will bind to serum albumin and gives an indication of how ‘available’ they will be for receptor interactions.

Despite such factors as serum albumin binding, it is generally found that increasing the hydrophobicity of a lead compound results in an increase in biological activity. This reflects the fact that drugs have to cross hydrophobic barriers such as cell membranes in order to reach their target. Even if no barriers are to be crossed (e.g. *in vitro* studies), the drug has to interact with a target system such as an enzyme or receptor where the binding site is usually hydrophobic. Therefore, increasing hydrophobicity aids the drug in crossing hydrophobic barriers or in binding to its target site.

This might imply that increasing $\log P$ should increase the biological activity *ad infinitum*. In fact, this does not happen. There are several reasons for this. For example, the drug may become so hydrophobic that it is poorly soluble in the aqueous phase. Alternatively, it may be ‘trapped’ in fat depots and never reach the intended site. Finally, hydrophobic drugs are often more susceptible to metabolism and subsequent elimination.

A straight-line relationship between $\log P$ and biological activity is observed in many QSAR studies because the range of $\log P$ values studied is often relatively narrow. For example, the study carried out on serum albumin binding was restricted to compounds having $\log P$ values in the range 0.78 to 3.82. If these studies were to be extended to include compounds with very high $\log P$ values then we would see a different picture. The graph would be parabolic, as shown in Fig. 9.3. Here, the biological activity increases as $\log P$ increases until a maximum value is obtained. The value of $\log P$ at the maximum ($\log P^0$) represents the optimum partition coefficient for biological activity. Beyond that point, an increase in $\log P$ results in a decrease in biological activity.

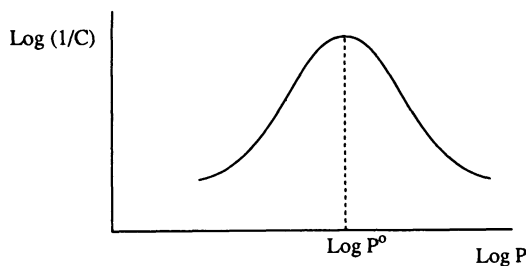

Fig. 9.3 Parabolic $\log (1/C)$ vs. $\log P$ curve.

In situations where the partition coefficient is the only factor influencing biological activity, the parabolic curve can be expressed by the mathematical equation:

$$\log \left(\frac{1}{C} \right) = -k_1(\log P)^2 + k_2 \log P + k_3.$$

Note that the $(\log P)^2$ term has a negative sign in front of it. When P is small, the $(\log P)^2$ term is very small and the equation is dominated by the $\log P$ term. This represents the first part of the graph where activity increases with increasing P . When

P is large, the $(\log P)^2$ term is more significant and eventually 'overwhelms' the $\log P$ term. This represents the last part of the graph where activity drops with increasing P . k_1 , k_2 , and k_3 are constants and can be determined by a suitable computer programme.

There are relatively few drugs where activity is related to the $\log P$ factor alone. Those that do, tend to operate in cell membranes where hydrophobicity is the dominant feature controlling their action. The best example of drugs which operate in cell membranes are the general anaesthetics. These are thought to function by entering the central nervous system and 'dissolving' into cell membranes where they affect membrane structure and nerve function. In such a scenario, there are no specific drug-receptor interactions and the mechanism of the drug is controlled purely by its ability to enter cell membranes (i.e. its hydrophobic character). The general anaesthetic activity of a range of ethers was found to fit the parabolic equation:

$$\log \left(\frac{1}{C} \right) = -0.22(\log P)^2 + 1.04 \log P + 2.16.$$

According to the equation, anaesthetic activity increases with increasing hydrophobicity (P), as determined by the $\log P$ factor. The negative $(\log P)^2$ factor shows that the relationship is parabolic and that there is an optimum value for $\log P$ ($\log P^0$) beyond which increasing hydrophobicity causes a decrease in anaesthetic activity.

With this equation, it is now possible to predict the anaesthetic activity of other ether structures, given their partition coefficients.

There are limitations to the use of this particular equation. For example, it is derived purely for anaesthetic ethers and is not applicable to other structural types of anaesthetics. This is generally true in QSAR studies. The procedure works best if it is applied to a series of compounds which have the same general structure.

QSAR studies have been carried out on other structural types of general anaesthetics and in each case a parabolic curve has been obtained. Although, the constants for each equation are different, it is significant that the optimum hydrophobicity (represented by $\log P^0$) for anaesthetic activity is close to 2.3, regardless of the class of anaesthetic being studied. This finding suggests that all general anaesthetics are operating in a similar fashion, controlled by the hydrophobicity of the structure.

Since different anaesthetics have similar $\log P^0$ values, the $\log P$ value of any compound can give some idea of its potential potency as an anaesthetic. For example, the $\log P$ values of the gaseous anaesthetics ether, chloroform, and halothane are 0.98, 1.97, and 2.3 respectively. Their anaesthetic activity increases in the same order.

Since general anaesthetics have a simple mechanism of action based on the efficiency with which they enter the central nervous system (CNS), it implies that $\log P$ values should give an indication of how easily any compound can enter the CNS. In other

words, compounds having a $\log P$ value close to 2 should be capable of entering the CNS efficiently.

This is generally found to be true. For example, the most potent barbiturates for sedative and hypnotic activity are found to have $\log P$ values close to 2.

As a rule of thumb, drugs which are to be targeted for the CNS should have a $\log P$ value of approximately 2. Conversely, drugs which are designed to act elsewhere in the body should have $\log P$ values significantly different from 2 in order to avoid possible CNS side-effects (e.g. drowsiness).

As an example of this, the cardiotoxic agent shown in Fig. 9.4(a) was found to produce ‘bright visions’ in some patients, which implied that it was entering the CNS. This was supported by the fact that the $\log P$ value of the drug was 2.59. In order to prevent the drug entering the CNS, the 4-OMe group was replaced with a 4-S(O)Me group. This particular group is approximately the same size as the methoxy group, but more hydrophilic. The $\log P$ value of the new drug (sulmazole) (Fig. 9.4(b)) was found to be 1.17. The drug was now too hydrophilic to enter the CNS and was free of CNS side-effects.

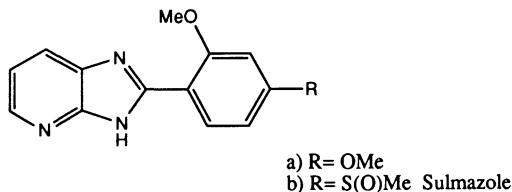

Fig. 9.4 Cardiotoxic agents.

The substituent hydrophobicity constant (π)

We have seen how the hydrophobicity of a compound can be quantified by using the partition coefficient P . However, in order to get P we have to measure it experimentally and that means that we have to synthesize the compounds. It would be much better if we could calculate P theoretically and decide in advance whether the compound is worth synthesizing. QSAR would then allow us to target the most promising looking structures. For example, if we were planning to synthesize a range of barbiturate structures, we could calculate $\log P$ values for them all and concentrate on the structures which had $\log P$ values closest to the optimum $\log P^0$ value for barbiturates.

Fortunately, partition coefficients can be calculated by knowing the contribution that various substituents make to hydrophobicity. This contribution is known as the substituent hydrophobicity constant (π).

The substituent hydrophobicity constant is a measure of how hydrophobic a substituent is, relative to hydrogen. The value can be obtained as follows. Partition coefficients are measured experimentally for a standard compound with and without a

substituent (X). The hydrophobicity constant (π_X) for the substituent (X) is then obtained using the following equation:

$$\pi_X = \log P_X - \log P_H$$

where P_H is the partition coefficient for the standard compound, and P_X is the partition coefficient for the standard compound with the substituent.

A positive value of π indicates that the substituent is more hydrophobic than hydrogen. A negative value indicates that the substituent is less hydrophobic. The π values for a range of substituents are shown in Fig. 9.5.

Group	CH ₃	Bu ^t	OH	OCH ₃	CF ₃	Cl	Br	F
π (Aliphatic Substituents)	0.50	1.68	-1.16	0.47	1.07	0.39	0.60	-0.17
π (Aromatic Substituents)	0.52	1.68	-0.67	-0.02	1.16	0.71	0.86	0.14

Fig. 9.5 π values for a range of substituents.

These π values are characteristic for the substituent and can be used to calculate how the partition coefficient of a drug would be affected by adding these substituents. The P value for the lead compound would have to be measured experimentally, but once that is known, the P value for analogues can be calculated quite simply.

As an example, consider the $\log P$ values for benzene ($\log P = 2.13$), chlorobenzene ($\log P = 2.84$), and benzamide ($\log P = 0.64$) (Fig. 9.6). Since benzene is the parent compound, the substituent constants for Cl and CONH₂ are 0.71 and -1.49 respectively. Having obtained these values, it is now possible to calculate the theoretical $\log P$ value for *meta*-chlorobenzamide:

$$\begin{aligned} \log P_{(\text{chlorobenzamide})} &= \log P_{(\text{benzene})} + \pi_{\text{Cl}} + \pi_{\text{CONH}_2} \\ &= 2.13 + 0.71 + (-1.49) \\ &= 1.35. \end{aligned}$$

The observed $\log P$ value for this compound is 1.51.

It should be noted that π values for aromatic substituents are different from those used for aliphatic substituents. Furthermore, neither of these sets of π values are in

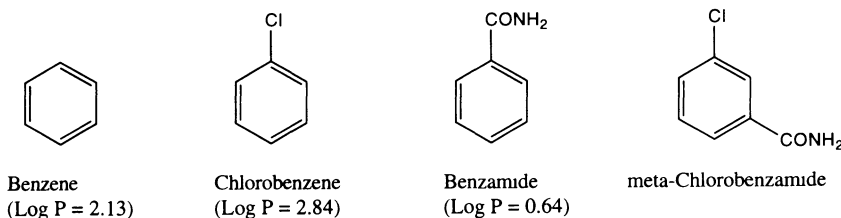

Fig. 9.6 Values for $\log P$.

fact true constants and are accurate only for the structures from which they were derived. They can be used as good approximations when studying other structures, but it is possible that the values will have to be adjusted in order to get accurate results.

P vs. π

QSAR equations relating biological activity to the partition coefficient *P* have already been described, but there is no reason why the substituent hydrophobicity constant π cannot be used in place of *P* if only the substituents are being varied.

The equation obtained would be just as relevant as a study of how hydrophobicity affects biological activity. That is not to say that *P* and π are exactly equivalent—different equations would be obtained with different constants.

Apart from the fact that the constants would be different, the two factors have different emphases. The partition coefficient *P* is a measure of the drug's overall hydrophobicity and is therefore an important measure of how efficiently a drug is transported to its target site and bound to its receptor. The π factor measures the hydrophobicity of a specific region on the drug's skeleton. Thus, any hydrophobic bonding to a receptor involving that region will be more significant to the equation than the overall transport process. If the substituent is involved in hydrophobic bonding to a receptor, then the QSAR equation using the π factor will emphasize that contribution to biological activity more dramatically than the equation using *P*.

Most QSAR equations will have a contribution from *P* or from π or from both. However, there are examples of drugs which have only a slight contribution. For example, a study on antimalarial drugs showed very little relationship between anti-malarial activity and hydrophobic character. This finding lends support to the theory that these drugs are acting in red blood cells, since previous research has shown that the ease with which drugs enter red blood cells is not related to their hydrophobicity.

9.3.2 Electronic effects

The electronic effects of various substituents will clearly have an effect on a drug's ionization or polarity. This in turn may have an effect on how easily a drug can pass through cell membranes or how strongly it can bind to a receptor. It is therefore useful to have some measure of the electronic effect a substituent can have on a molecule.

As far as substituents on an aromatic ring are concerned, the measure used is known as the Hammett substitution constant which is given the symbol σ .

The Hammett substitution constant (σ) is a measure of the electron withdrawing or electron donating ability of a substituent and has been determined by measuring the dissociation of a series of substituted benzoic acids compared to the dissociation of benzoic acid itself.

Benzoic acid is a weak acid and only partially ionizes in water (Fig. 9.7).

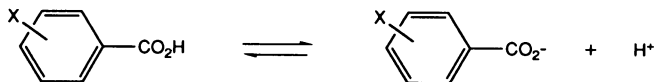

Fig. 9.7 Ionization of benzoic acid.

An equilibrium is set up between the ionized and non-ionized forms, where the relative proportions of these species is known as the equilibrium or dissociation constant K_H (the subscript H signifies that there are no substituents on the aromatic ring).

$$K_H = \frac{[\text{PhCO}_2^-]}{[\text{PhCO}_2\text{H}]}$$

When a substituent is present on the aromatic ring, this equilibrium is affected. Electron withdrawing groups, such as a nitro group, result in the aromatic ring having a stronger electron withdrawing and stabilizing influence on the carboxylate anion. The equilibrium will therefore shift more to the ionized form such that the substituted benzoic acid is a stronger acid and has a larger K_X value (X represents the substituent on the aromatic ring) (Fig. 9.8).

If the substituent X is an electron donating group such as an alkyl group, then the aromatic ring is less able to stabilize the carboxylate ion. The equilibrium shifts to the left and a weaker acid is obtained with a smaller K_X value (Fig. 9.8).

The Hammett substituent constant (σ_X) for a particular substituent (X) is defined by the following equation:

$$\sigma_X = \log \frac{K_X}{K_H} = \log K_X - \log K_H$$

Benzoic acids containing electron withdrawing substituents will have larger K_X values than benzoic acid itself (K_H) and therefore the value of σ_X for an electron withdrawing substituent will be positive. Substituents such as Cl, CN, or CF_3 have positive σ values.

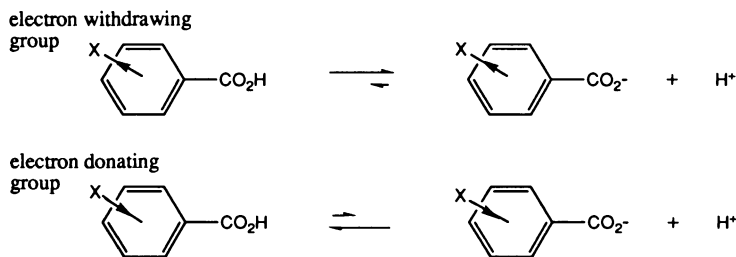

Fig. 9.8 Position of equilibrium dependent on substituent group X.

Benzoic acids containing electron donating substituents will have smaller K_X values than benzoic acid itself and hence the value of σ_X for an electron donating substituent will be negative. Substituents such as Me, Et, and Bu' have negative σ values. The Hammett substituent constant for H will be zero.

The Hammett constant takes into account both resonance and inductive effects. Therefore, the value of σ for a particular substituent will depend on whether the substituent is *meta* or *para*. This is indicated by the subscript *m* or *p* after the σ symbol.

For example, the nitro substituent has $\sigma_p = 0.78$ and $\sigma_m = 0.71$. In the *meta* position, the electron withdrawing power is due to the inductive influence of the substituent, whereas at the *para* position inductive and resonance both play a part and so the σ_p value is greater (Fig. 9.9).

Meta Nitro Group - Electronic Influence on R is inductive

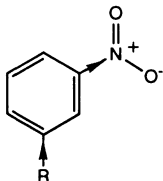

Para Nitro Group - Electronic Influence on R is due to Inductive and Resonance Effects

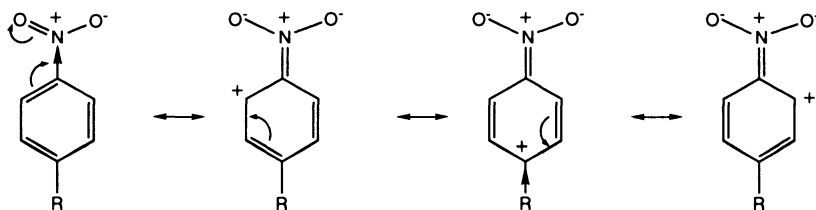
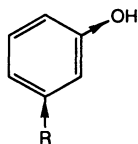

Fig. 9.9

For the OH group $\sigma_m = 0.12$ while $\sigma_p = -0.37$. At the *meta* position, the influence is inductive and electron withdrawing. At the *para* position, the electron donating influence due to resonance is more significant than the electron withdrawing influence due to induction (Fig. 9.10).

Most QSAR studies start off by considering σ and if there is more than one substituent, the σ values are summed ($\Sigma\sigma$). However, as more compounds are synthesized, it is possible to refine or fine-tune the QSAR equation. As mentioned above, σ is a measure of a substituent's inductive and resonance electronic effects. With more detailed studies, the inductive and resonance effects can be considered

Meta Hydroxyl Group - Electronic Influence on R is inductive



Para Hydroxyl Group - Electronic Influence on R dominated by Resonance Effects

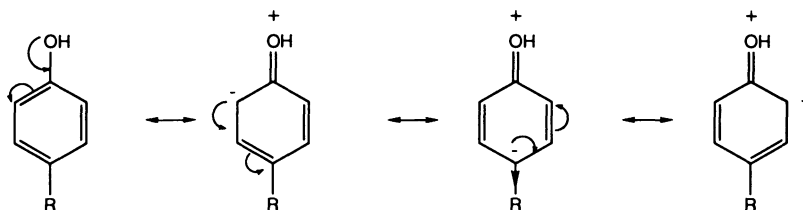

Fig. 9.10

separately. Tables of constants are available which quantify a substituent's inductive effect (F) and its resonance effect (R). In some cases, it might be found that a substituent's effect on activity is due to F rather than R , and vice versa. It might also be found that a substituent has a more significant effect at a particular position on the ring and this can also be included in the equation.

There are limitations to the electronic constants which we have described so far. For example, Hammett Substituent Constants cannot be measured for *ortho* substituents since such substituents have an important steric, as well as electronic, effect.

There are very few drugs whose activities are solely influenced by a substituent's electronic effect, since hydrophobicity usually has to be considered as well. Those that do are generally operating by a mechanism whereby they do not have to cross any cell membranes. Alternatively, *in vitro* studies on isolated enzymes may result in QSAR equations lacking the hydrophobicity factor, since there are no cell membranes to be considered.

The insecticidal activity of diethyl phenyl phosphates (Fig. 9.11) is one of the few examples where activity is related to electronic factors alone:

$$\log \left(\frac{1}{C} \right) = 2.282\sigma - 0.348.$$

The equation reveals that substituents with a positive value for σ (i.e. electron withdrawing groups) will increase activity. The fact that the π parameter is not significant is a good indication that the drugs do not have to pass into or through a cell

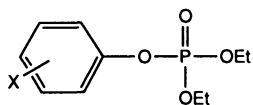

Fig. 9.11 Diethyl phenyl phosphate.

membrane to have activity. In fact, these drugs are known to act against an enzyme called acetylcholinesterase which is situated on the outside of cell membranes (see Chapter 11).

The above constants (σ , R , and F) can only be used for aromatic substituents and are therefore only suitable for drugs containing aromatic rings. However, a series of aliphatic electronic substituent constants are available. These were obtained by measuring the rates of hydrolysis for a series of aliphatic esters (Fig. 9.12). Methyl ethanoate is the parent ester and it is found that the rate of hydrolysis is affected by the substituent X. The extent to which the rate of hydrolysis is affected is a measure of the substituent's electronic effect at the site of reaction (i.e. the ester group). The electronic effect is purely inductive and is given the symbol σ_1 . Electron donating groups reduce the rate of hydrolysis and therefore have negative values. For example, σ_1 values for methyl, ethyl, and propyl are -0.04 , -0.07 , and -0.36 respectively. Electron withdrawing groups increase the rate of hydrolysis and have positive values. The σ_1 values for NMe_3^+ and CN are 0.93 and 0.53 respectively.

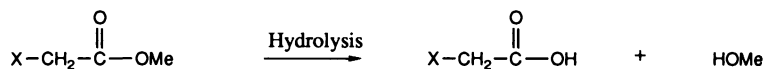

Fig. 9.12 Hydrolysis of an aliphatic ester.

It should be noted that the inductive effect is not the only factor affecting the rate of hydrolysis. The substituent may also have a steric effect. For example, a bulky substituent may 'shield' the ester from attack and lower the rate of hydrolysis. It is therefore necessary to separate out these two effects. This can be done by measuring hydrolysis rates under basic conditions and also under acidic conditions. Under basic conditions, steric and electronic factors are important, whereas under acidic conditions only steric factors are important. By comparing the rates, values for the electronic effect (σ_1), and for the steric effect (E_S) (see below) can be determined.

9.3.3 Steric factors

In order for a drug to interact with an enzyme or a receptor, it has to approach, then bind to a binding site. The bulk, size, and shape of the drug may have an influence on this process. For example, a bulky substituent may act like a shield and hinder the ideal interaction between drug and receptor. Alternatively, a bulky substituent may help to orientate a drug properly for maximum receptor binding and increase activity.

Quantifying steric properties is more difficult than quantifying hydrophobic or electronic properties. Several methods have been tried and three are described here. It is highly unlikely that a drug's biological activity will be affected by steric factors alone, but these factors are frequently to be found in Hansch equations (Section 9.4.).

Taft's steric factor (E_s)

Attempts have been made to quantify the steric features of substituents by using Taft's steric factor (E_s). The value for E_s can be obtained as described in Section 9.3.2. However, the number of substituents which can be studied by this method is restricted.

Molar refractivity (MR)

Another measure of the steric factor is provided by a parameter known as molar refractivity (MR). This is a measure of the volume occupied by an atom or group of atoms. The molar refractivity is obtained from the following equation:

$$MR = \frac{(n^2 - 1)}{(n^2 + 2)} \times \frac{MW}{d}$$

where n is the index of refraction, MW is the molecular weight, and d is the density. The term MW/d defines a volume, while the $(n^2 - 1)/(n^2 + 2)$ term provides a correction factor by defining how easily the substituent can be polarized. This is particularly significant if the substituent has pi electrons or lone pairs of electrons.

Verloop steric parameter

Another approach to measuring the steric factor involves a computer programme called STERIMOL which calculates steric substituent values (Verloop steric parameters) from standard bond angles, van der Waals radii, bond lengths, and possible conformations for the substituent. Unlike E_s , the Verloop steric parameter can be measured for any substituent.

9.3.4 Other physicochemical parameters

The physicochemical properties most commonly studied by the QSAR approach have been described above, but other properties have also been studied. These include dipole moments, hydrogen bonding, conformation, and interatomic distances. However, difficulties in quantifying these properties limit the use of these parameters.

9.4 Hansch equation

In Section 9.3. we looked at the physicochemical properties commonly used in QSAR studies and how it is possible to quantify them. In a simple situation where biological

activity is related to only one such property, a simple equation can be drawn up. However, the biological activity of most drugs is related to a combination of physicochemical properties. In such cases, simple equations involving only one parameter are relevant only if the other parameters are kept constant. In reality, this is not easy to achieve and equations which relate biological activity to more than one parameter are more common. These equations are known as Hansch equations and they usually relate biological activity to the most commonly used physicochemical properties (P and/or π , σ , and a steric factor). If the range of hydrophobicity values is limited to a small range then the equation will be linear as follows:

$$\log\left(\frac{1}{C}\right) = k_1 \log P + k_2 \sigma + k_3 E_s + k_4.$$

If the P values are spread over a large range then the equation will be parabolic for the same reasons described in Section 9.3.1.

$$\log\left(\frac{1}{C}\right) = -k(\log P)^2 + k_2 \log P + k_3 \sigma + k_4 E_s + k_5.$$

The constants k_1 – k_5 are determined by computer in order to get the best fitting line.

Not all the parameters will necessarily be significant. For example, the adrenergic blocking activity of β -halo- β -arylamines (Fig. 9.13) was related to π and σ and did not include a steric factor:

$$\log\left(\frac{1}{C}\right) = 1.22\pi - 1.59\sigma + 7.89.$$

This equation tells us that biological activity increases if the substituents have a positive π value and a negative σ value. In other words, the substituents should be hydrophobic and electron donating.

Since the P value and the π factor are not necessarily correlated, it is possible to have Hansch equations containing both of these factors. For example, a series of 102 phenanthrene aminocarbinols (Fig. 9.14) were tested for antimalarial activity and found to fit the following equation:

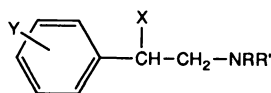

Fig. 9.13 β -Halo- β -arylamines.

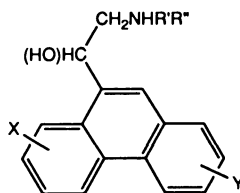

Fig. 9.14 Phenanthrene aminocarbinol structure.

$$\log\left(\frac{1}{C}\right) = -0.015(\log P)^2 + 0.14 \log P + 0.27\sum\pi_X + 0.40\sum\pi_Y + 0.65\sum\sigma_X + 0.88\sum\sigma_Y + 2.34.$$

This equation tells us that antimalarial activity increases very slightly as the hydrophobicity of the molecule (P) increases. The constant of 0.14 is low and shows that the increase is slight. The $(\log P)^2$ term shows that there is an optimum P value for activity. The equation also shows that activity increases significantly if hydrophobic substituents are present on ring X and in particular on ring Y. This could be taken to imply that some form of hydrophobic interaction is involved at these sites. Electron withdrawing substituents on both rings are also beneficial to activity, more so on ring Y than ring X.

When carrying out a Hansch analysis, it is important to choose the substituents carefully to ensure that the change in biological activity can be attributed to a particular parameter. There are plenty of traps for the unwary. Take, for example, drugs which contain an amine group. One of the most frequently carried out studies on amines is to synthesize analogues containing a homologous series of alkyl substituents on the nitrogen atom (i.e. Me, Et, Prⁿ, Buⁿ). If activity increases with the chain length of the substituent, is it due to increasing hydrophobicity or to increasing size or to both? If we look at the π and MR values of these substituents, then we find that both increase in a similar fashion across the series and we would not be able to distinguish between them (Fig. 9.15).

Substituent	H	Me	Et	Pr ⁿ	Bu ⁿ	OMe	NHCONH ₂	I	CN
π	0.00	0.56	1.02	1.50	2.13	-0.02	-1.30	1.12	-0.57
MR	0.10	0.56	1.03	1.55	1.96	0.79	1.37	1.39	0.63

Fig. 9.15 Values for π and MR for a series of substituents.

In this example, a series of substituents would have to be chosen where π and MR are not related. The substituents H, Me, OMe, NHCOCH₂, I, and CN would be more suitable.

9.5 The Craig plot

Although tables of π and σ factors are readily available for a large range of substituents, it is often easier to visualize the relative properties of different substituents by considering a plot where the y axis is the value of the σ factor and the x axis is the value of the π factor. Such a plot is known as a Craig plot. The example shown in Fig.

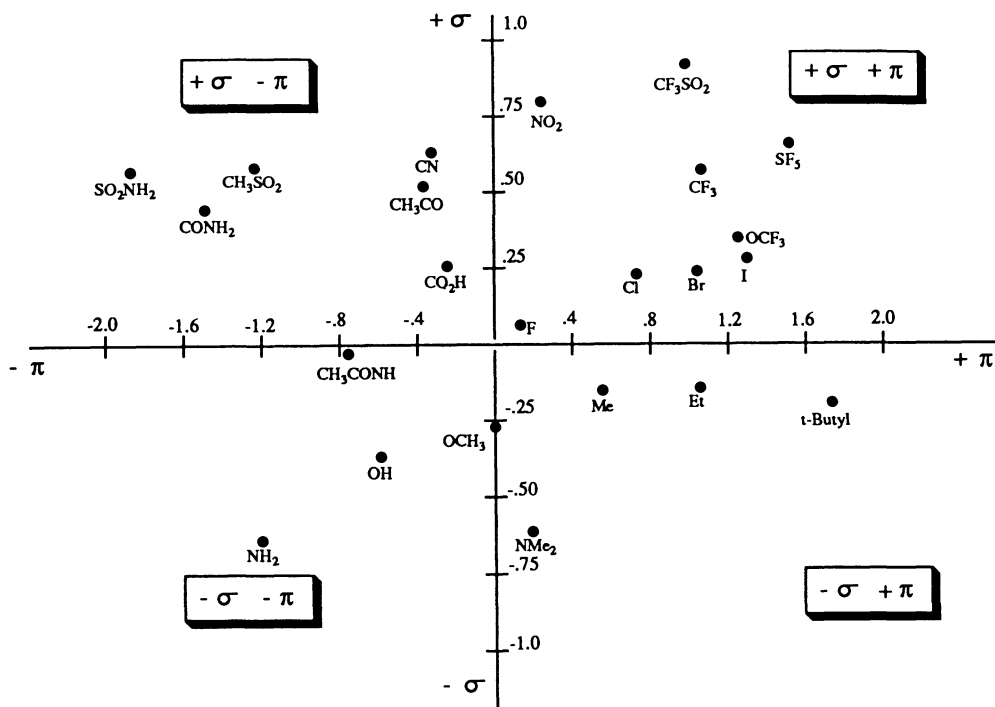

Fig. 9.16 Craig plot.

9.16 is the Craig plot for the σ and π factors of *para*-aromatic substituents. There are several advantages to the use of such a Craig plot.

- The plot shows clearly that there is no overall relationship between π and σ . The various substituents are scattered around all four quadrants of the plot.
- It is possible to tell at a glance which substituents have positive π and σ parameters, which substituents have negative π and σ parameters, and which substituents have one positive and one negative parameter.
- It is easy to see which substituents have similar π values. For example, the ethyl, bromo, trifluoromethyl, and trifluoromethylsulfonyl groups are all approximately on the same vertical line on the plot. In theory, these groups could be interchangeable on drugs where the principal factor affecting biological activity is the π factor. Similarly, groups which form a horizontal line can be identified as being isoelectronic or having similar σ values (e.g. CO_2H , Cl, Br, I).
- The Craig plot is useful in planning which substituents should be used in a QSAR study. In order to derive the most accurate equation involving π and σ , analogues should be synthesized with substituents from each quadrant. For example, halide substituents are useful representatives of substituents with increased hydrophobicity

and electron withdrawing properties (positive π and positive σ), whereas an OH substituent has more hydrophilic and electron donating properties (negative π and negative σ). Alkyl groups are examples of substituents with positive π and negative σ values, whereas acyl groups have negative π and positive σ values.

- Once the Hansch equation has been derived, it will show whether π or σ should be negative or positive in order to get good biological activity. Further developments would then concentrate on substituents from the relevant quadrant. For example, if the equation shows that positive π and positive σ values are necessary, then further substituents should only be taken from the top right quadrant.

Craig plots can also be drawn up to compare other sets of physicochemical parameters, such as hydrophobicity and MR .

9.6 The Topliss scheme

In certain situations, it might not be feasible to make the large range of structures required for a Hansch equation. For example, the synthetic route involved might be difficult and only a few structures can be made in a limited time. In these circumstances, it would be useful to test compounds for biological activity as they are synthesized and to use these results to determine the next analogue to be synthesized.

A Topliss scheme is a 'flow diagram' which allows such a procedure to be followed. There are two Topliss schemes, one for aromatic substituents (Fig. 9.17) and one for aliphatic side-chain substituents (Fig. 9.18). The schemes were drawn up by considering the hydrophobicity and electronic factors of various substituents and are designed such that the optimum substituent can be found as efficiently as possible. However, they are not meant to be a replacement for a full Hansch analysis. Such an analysis

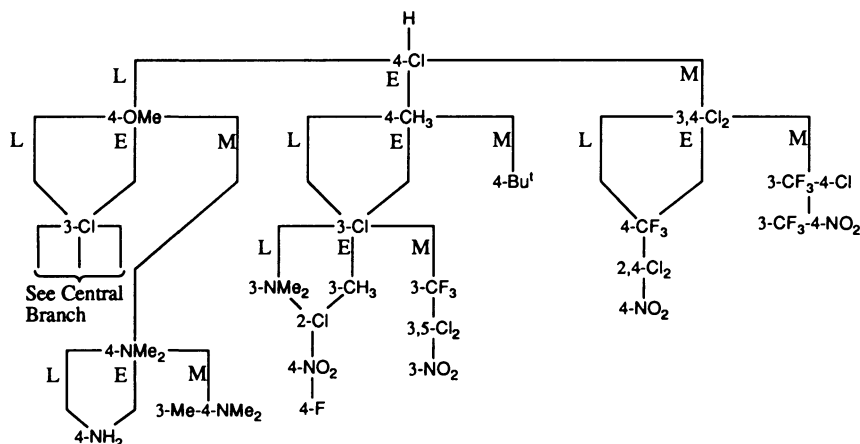

Fig. 9.17 Topliss scheme for aromatic substituents.

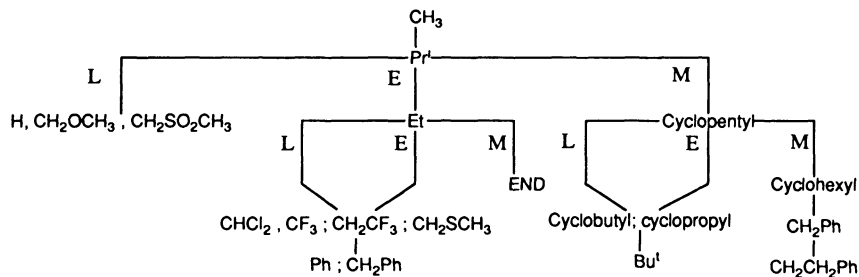

Fig. 9.18 Topliss scheme for aliphatic side chain substituents.

would be carried out in due course, once a suitable number of structures have been synthesized.

The Topliss scheme for aromatic substituents (Fig. 9.17) assumes that the lead compound has been tested for biological activity and contains a monosubstituted aromatic ring. The first analogue in the scheme is the 4-chloro derivative, since this derivative is usually easy to synthesize. The chloro substituent is more hydrophobic and electron withdrawing than hydrogen and therefore, π and σ are positive.

Once the chloro analogue has been synthesized, the biological activity is measured. There are three possibilities. The analogue will have less activity (L), equal activity (E), or more activity (M). The type of activity observed will determine which branch of the Topliss scheme is followed next.

If the biological activity increases, then the (M) branch is followed and the next analogue to be synthesized is the 3,4-dichloro-substituted analogue. If, on the other hand, the activity stays the same, then the (E) branch is followed and the 4-methyl analogue is synthesized. Finally, if activity drops, the (L) branch is followed and the next analogue is the 4-methoxy analogue.

Biological results from the second analogue now determine the next branch to be followed in the scheme.

What is the rationale behind this?

Let us consider the situation where the 4-chloro derivative increases in biological activity. Since the chloro substituent has positive π and σ values, it implies that one or both of these properties are important to biological activity. If both are important, then adding a second chloro group should increase biological activity yet further. If it does, substituents are varied to increase the π and σ values even further. If it does not, then an unfavourable steric interaction or excessive hydrophobicity is indicated. Further modifications then test the relative importance of π and steric factors.

We shall now consider the situation where the 4-chloro analogue drops in activity. This suggests either that negative π and/or σ values are important to activity or that a *para* substituent is sterically unfavourable. It is assumed that an unfavourable σ effect is the most likely reason for the reduced activity and so the next substituent is one

with a negative σ factor (i.e. 4-OMe). If activity improves, further changes are suggested to test the relative importance of the σ and π factors. If, on the other hand, the 4-OMe group does not improve activity, it is assumed that an unfavourable steric factor is at work and the next substituent is a 3-chloro group. Modifications of this group would then be carried out in the same way as shown in the centre branch of Fig. 9.17.

The last scenario is where the activity of the 4-chloro analogue is little changed from the lead compound. This could arise from the drug requiring a positive π value and a negative σ value. Since both values for the chloro group are positive, the beneficial effect of the positive π value might be cancelled out by the detrimental effects of a positive σ value. The next substituent to try in that case is the 4-methyl group which has the necessary positive π value and negative σ value. If this still has no beneficial effect, then it is assumed that there is an unfavourable steric interaction at the *para* position and the 3-chloro substituent is chosen next. Further changes continue to vary the relative values of the π and σ factors.

The validity of the Topliss scheme was tested by looking at structure–activity results for various drugs which had been reported in the literature. For example, the biological activity of nineteen substituted benzenesulfonamides (Fig. 9.19) have been reported. The second most active compound was the nitro-substituted analogue which would have been the fifth compound synthesized if the Topliss scheme had been followed.

Another example comes from the anti-inflammatory activities of substituted aryl-tetrazolylalkanoic acids (Fig. 9.20). Twenty-eight of these were synthesized. Using the Topliss scheme, three out of the four most active structures would have been synthesized from the first eight compounds synthesized.

The Topliss scheme for aliphatic side-chains (Fig. 9.18) was set up following a similar rationale to the aromatic scheme, and is used in the same way for side-groups attached to a carbonyl, amino, amide, or similar functional group. The scheme only attempts to differentiate between the hydrophobic and electronic effects of substituents and not the steric properties. Thus, the substituents involved have been chosen to try and minimize any steric differences. It is assumed that the lead com-

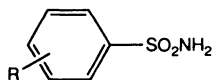

Order of Synthesis	R	Biological Activity	High Potency
1	H	-	
2	4-Cl	M	
3	3,4-Cl ₂	L	
4	4-Br	E	
5	4-NO ₂	M	*

M= More Activity
L= Less Activity
E = Equal Activity

Fig. 9.19 Biological activity of substituted benzenesulfonamides.

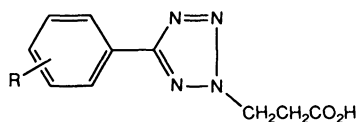

Order of Synthesis	R	Biological Activity	High Potency
1	H	-	
2	4-Cl	L	
3	4-MeO	L	
4	3-Cl	M	*
5	3-CF ₃	L	
6	3-Br	M	*
7	3-I	L	
8	3,5-Cl ₂	M	*

M= More Activity

L= Less Activity

E = Equal Activity

Fig. 9.20 Anti-inflammatory activities of substituted aryltetrazolylacetic acids.

pound has a methyl group. The first analogue suggested is the isopropyl analogue. This has an increased π value and in most cases would be expected to increase activity, since it has been found from experience that the hydrophobicity of most lead compounds are less than the optimum hydrophobicity required for activity.

Let us concentrate first of all on the situation where activity rises. Following this branch, a cyclopentyl group is now used. A cyclic structure is used since it has a larger π value, but keeps any increase in steric factor to a minimum. If activity rises again, more hydrophobic substituents are tried. If activity does not rise, then there could be two explanations. Either the optimum hydrophobicity has been passed or there is an electronic effect (σ_1) at work. Further substituents are then used to determine which is the correct explanation.

Let us now look at the situation where the activity of the isopropyl analogue stays much the same. The most likely explanation is that the methyl group and the isopropyl group are on either side of the hydrophobic optimum. Therefore, an ethyl group is used next, since it has an intermediate π value. If this does not lead to an improvement, it is possible that there is an unfavourable electronic effect. The groups used have been electron donating, and so electron withdrawing groups with similar π values are now suggested.

Finally, we shall look at the case where activity drops for the isopropyl group. In this case, hydrophobic and/or electron donating groups could be bad for activity and the groups suggested are suitable choices for further development.

The Topliss scheme has proved useful many times, but it will not work in every case, and it is not meant to be a replacement for more detailed QSAR studies.

9.7 Bioisosteres

Tables of substituent constants are available for various physicochemical properties. A knowledge of these constants allows the medicinal chemist to identify substituents

Substituent						
π	-0.55	0.40	-1.58	-1.63	-1.82	-1.51
σ_p	0.50	0.84	0.49	0.72	0.57	0.36
σ_m	0.38	0.66	0.52	0.60	0.46	0.35
MR	11.2	21.5	13.7	13.5	16.9	19.2

Fig. 9.21 Physicochemical parameters for six substituents.

which may be potential bioisosteres. Thus, the substituents CN, NO₂, and COMe have similar hydrophobic, electronic, and steric factors, and might be interchangeable. Such interchangeability was observed in the development of cimetidine (Chapter 13). The important thing to notice is that groups can be bioisosteric in some situations, but not others. Consider for example the table shown in Fig. 9.21.

This table shows some physicochemical parameters for six different substituents. If the most important physicochemical parameter for biological activity is σ_p , then the COCH₃ group (0.50) would be a reasonable bioisostere for the SOCH₃ group (0.49). If, on the other hand, the dominant parameter is π , then a more suitable bioisostere for SOCH₃ (-1.58) would be SO₂CH₃ (-1.63).

9.8 Planning a QSAR study

When starting a QSAR study it is important to decide which physicochemical parameters are going to be studied and to plan the analogues such that the parameters under study are suitably varied. For example, it would be pointless to synthesize analogues where the hydrophobicity and steric volume of the substituents are correlated, if these two parameters are to go into the equation.

It is also important to make enough structures to make the results statistically meaningful. As a rule of thumb, five structures should be made for every parameter studied. Typically, the initial QSAR study would involve the two parameters π and σ , and possibly E_s . Craig plots could be used in order to choose suitable substituents.

Certain substituents are worth avoiding in the initial study since they may have properties other than those being studied. For example, substituents which might ionize (CO₂H, NH₂, SO₂H) should be avoided. Groups which might easily be metabolized should be avoided if possible (e.g. esters or nitro groups).

If there are two or more substituents, then the initial equation usually considers the total π and σ contribution.

As more analogues are made, it is often possible to consider the hydrophobic and electronic effect of substituents at specific positions of the molecule. Furthermore, the electronic parameter σ can be split into its inductive and resonance components (F and R). Such detailed equations may show up a particular localized requirement for

activity. For example, a hydrophobic substituent may be favoured in one part of the skeleton, while an electron withdrawing substituent is favoured at another. This in turn gives clues about the binding interactions involved between drug and receptor.

9.9 Case study

An example of how the QSAR equation can change and become more specific as a study develops is demonstrated from a study carried out by workers at Smith, Kline, & French on the antiallergic activity of a series of pyranenamines (Fig. 9.22). In this study, substituents were varied on the aromatic ring, and the remainder of the molecule was kept constant. Nineteen compounds were synthesized and the first QSAR equation was obtained by only considering π and σ :

$$\log \left(\frac{1}{C} \right) = -0.14 \Sigma \pi - 1.35 (\Sigma \sigma)^2 - 0.72$$

where $\Sigma \pi$ and $\Sigma \sigma$ are the total π and σ values for all substituents present.

The negative coefficient for the π term shows that activity is inversely proportional to hydrophobicity, which is quite unusual. The $(\Sigma \sigma)^2$ term is also quite unusual. It was chosen since there was no simple relationship between activity and σ . In fact, it was observed that activity dropped if the substituent was electron withdrawing or electron donating. Activity was best with neutral substituents. To take account of this, the $(\Sigma \sigma)^2$ term was introduced. Since the coefficient in the equation is negative, activity is lowered if σ is anything other than zero.

A further range of compounds were synthesized with hydrophilic substituents to test this equation, making a total of 61 structures. This resulted in the following inconsistencies.

- The activities for the substituents 3-NHCOMe, 3-NHCOEt, and 3-NHCOPr were all similar. However, according to the equation, the activities should have dropped as the alkyl group became larger due to increasing hydrophobicity.
- Activity was greater than expected if there was a substituent such as OH, SH, NH₂, or NHCOR, at position 3, 4, or 5.
- The substituent NHSO₂R was bad for activity.
- The substituents 3,5-(CF₃)₂ and 3,5-(NHCOMe)₂ had much greater activity than expected.

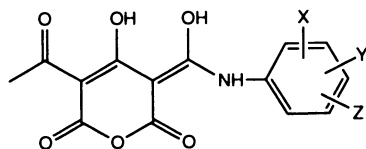

Fig. 9.22 Structure of pyranenamine.

- An acyloxy group at the 4-position resulted in an activity five times greater than predicted by the equation.

These results implied that the initial equation was too simple and that properties other than π and σ were important to activity. At this stage, the following theories were proposed to explain the above results.

- The similar activities for 3-NHCOMe, 3-NHCOEt, and 3-NHCOPr could be due to a steric factor. The substituents had increasing hydrophobicity which is bad for activity, but they were also increasing in size and it was proposed that this was good for activity. The most likely explanation is that the size of the substituent is forcing the drug into the correct orientation for optimum receptor interaction.
- The substituents which unexpectedly increased activity when they were at positions 2, 3, or 4 are all capable of hydrogen bonding. This suggests an important hydrogen bonding interaction with the receptor. For some reason, the NHSO_2R group is an exception, which implies there is some other unfavourable steric or electronic factor peculiar to this group.
- The increased activity for 4-acyloxy groups was explained by suggesting that these analogues are acting as prodrugs. The acyloxy group is less polar than the hydroxyl group and so these analogues would be expected to cross cell membranes and reach the receptor more efficiently than analogues bearing a free hydroxyl group. At the receptor, the ester group could be hydrolysed to reveal the hydroxyl group which would then take part in hydrogen bonding with the receptor.
- The structures having substituents 3,5-(CF_3)₂ and 3,5-(NHCOMe)₂ are the only disubstituted structures where a substituent at position 5 has an electron withdrawing effect, so this feature was also introduced into the next equation.

The revised QSAR equation was as follows:

$$\log \left(\frac{1}{C} \right) = -0.30 \sum \pi - 1.5 (\sum \sigma)^2 + 2.0(F-5) + 0.39(345\text{-HBD}) - 0.63(\text{NHSO}_2) + 0.78(M-V) + 0.72(4\text{-OCO}) - 0.75.$$

The π and σ parameters are still present, but a number of new parameters have now appeared.

- The $F-5$ term represents the inductive effect of a substituent at position 5. Since the coefficient is positive and large, it shows that an electron withdrawing group substantially increases activity. However, since only 2 compounds in the 61 synthesized had a 5-substituent, there might be quite an error in this result.
- The advantage of having hydrogen bonding substituents at position 3,4, or 5 is accounted for by including a hydrogen bonding term (345-HBD). The value of this term depends on the number of hydrogen bonding substituents present. If one such

group is present, the *345-HBD* term is 1. If two such groups were present, the parameter is 2. Therefore, for each hydrogen bonding substituent present at positions 3, 4, or 5, $\log(1/C)$ increases by 0.39.

- The *NHSO₂* term was introduced since this group was poor for activity despite being capable of hydrogen bonding. The negative coefficient indicates the drop in activity. A figure of 1 is used for any *NHSO₂R* substituent present.
- The *M-V* term represents the volume of any *meta* substituent, and since the coefficient is positive, it indicates that substituents with a large volume at the *meta* position increase activity.
- The *4-OCO* term is either 0 or 1 and is only present if an acyloxy group is present at position 4, and so $\log(1/C)$ is increased by 0.72 if the acyl group is present.

The most important parameters in the above equation are the hydrophobic parameter and the *4-OCO* parameter.

A further 37 structures were synthesized to test steric and *F-5* parameters as well as exploring further groups capable of hydrogen bonding. Since hydrophilic substituents were good for activity, a range of very hydrophilic substituents were also tested to see if there was an optimum value for hydrophilicity.

The results obtained highlighted one more anomaly in that two hydrogen bonding groups *ortho* to each other were bad for activity. This was attributed to the groups hydrogen bonding with each other rather than to the receptor.

A revised equation was obtained as follows:

$$\log\left(\frac{1}{C}\right) = -0.034(\Sigma\pi)^2 - 0.33(\Sigma\pi) + 4.3(F-5) + 1.3(R-5) - 1.7(\Sigma\sigma)^2 + 0.73(345-HBD) - 0.86(HB-INTRA) - 0.69(NHSO_2) + 0.72(4-OCO) - 0.59.$$

The main points of interest from this equation are as follows.

- Increasing the hydrophilicity of substituents allowed the identification of an optimum value for hydrophobicity ($\Sigma\pi = -5$) and introduced the $(\Sigma\pi)^2$ parameter into the equation. The value of -5 is remarkably low and indicates that the receptor site is hydrophilic.
- As far as electronic effects are concerned, it is revealed that the resonance effects of substituents at the 5-position also have an influence on activity.
- The unfavourable situation where two hydrogen bonding groups are *ortho* to each other is represented by the *HB-INTRA* parameter. This parameter is given the value 1 if such an interaction is possible and the negative constant (-0.86) shows that such interactions decrease activity.
- It is interesting to note that the steric parameter is no longer significant and has disappeared from the equation.

The compound having the greatest activity has two $\text{NHCOCH}(\text{OH})\text{CH}_2\text{OH}$ substituents at the 3- and 5-positions and is 1000 times more active than the original lead compound. The substituents are very polar and are not ones which would normally be used. They satisfy all the requirements determined by the QSAR study. They are highly polar groups which can take part in hydrogen bonding. They are *meta* with respect to each other, rather than *ortho*, to avoid undesirable intramolecular hydrogen bonding. One of the groups is at the 5-position and has a favourable $F-5$ parameter. Together the two groups have a negligible $(\Sigma\sigma)^2$ value. Such an analogue would certainly not have been obtained by trial and error and this example demonstrates the strengths of the QSAR approach.

All the evidence from this study suggests that the aromatic ring of this series of compounds is fitting into a hydrophilic pocket in the receptor which contains polar groups capable of hydrogen bonding.

It is further proposed that a positively charged residue such as arginine, lysine, or histidine might be present in the pocket which could interact with an electronegative substituent at position 5 of the aromatic ring. (Fig. 9.23).

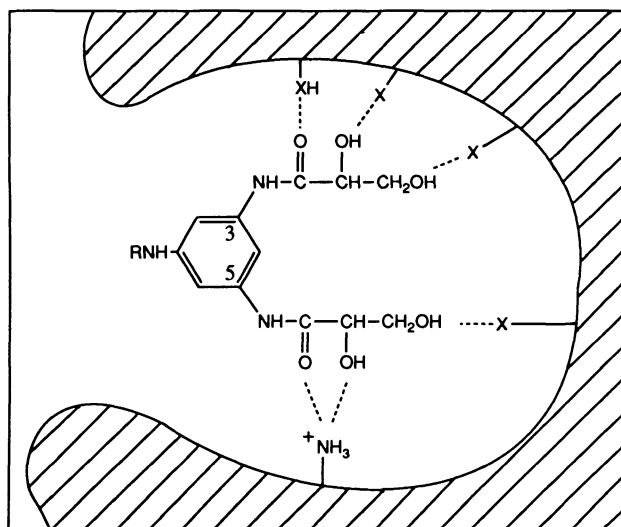

Fig. 9.23 Hypothetical receptor binding interactions of a pyranenamine.

This example demonstrates that QSAR studies and computers are powerful tools in medicinal chemistry. However, it also shows that the QSAR approach is a long way from replacing the human factor. One cannot put a series of facts and figures into a computer and expect it to magically produce an instant explanation of how a drug works. The medicinal chemist still has to interpret results, propose theories, and test those theories by incorporating the correct parameters into the QSAR equation. Imagination and experience still count for a great deal.